

MVSP-220 series

SOLENOID VALVE



mindman



Specification

Model	3E1	3E2	4E1	4E2	4E2 C.P.R
Port size	Rc1/4		Rc1/8, Rc1/4		
No. of port / position	3/2		5/2	5/3	
Medium	Air				
Operating pressure range	0.2~0.8 MPa			0.3~0.8 MPa	
Proof pressure	1 MPa				
Effective orifice	18 mm ²			16 mm ²	
Response time	30 ms			40 ms	
Ambient temperature	-5~+50°C (No freezing)				
Voltage	AC110V, 220V (50/60)Hz, DC24/12V				
Power consumption	AC=2.5VA, DC=0.95W				
Available voltage range	±10%				
Insulation class	F class				
Weight	86 g	130 g	108 g	152 g	198 g

Order example of valve

MVSP – 220M – 4E2C – NC – □ – AC110 – H1 – G

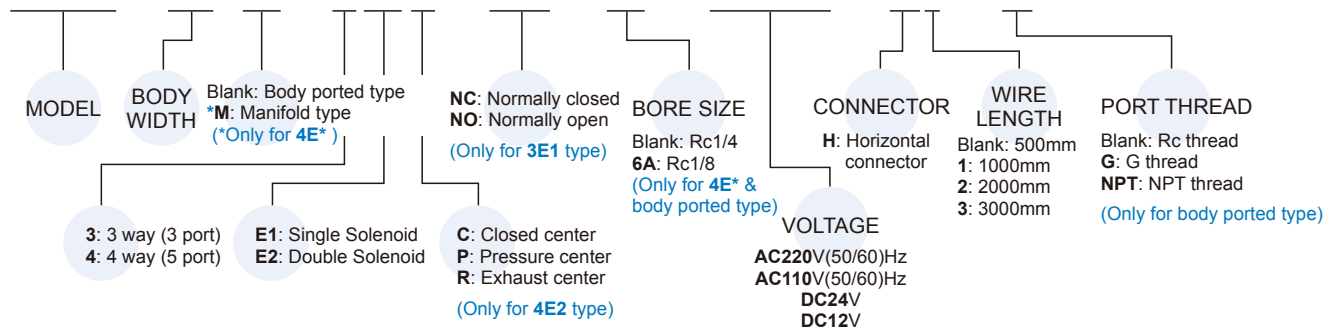

Order example of manifold

MVSC – 220M – 5B3 – G

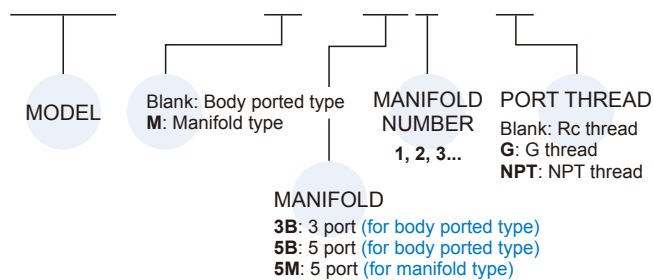

Order example of wire

* Use the same wire with MVDY.

MVDY – 100 – WA2J2

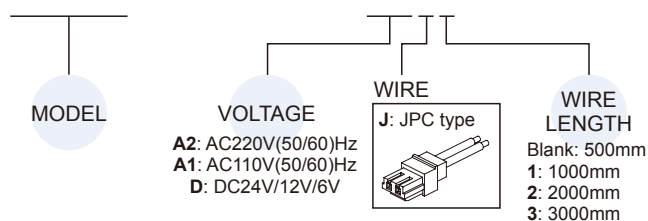

Caution

Prohibit apply force to coil when tighten the tube fitting.

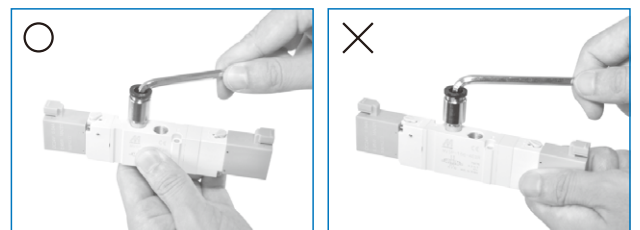
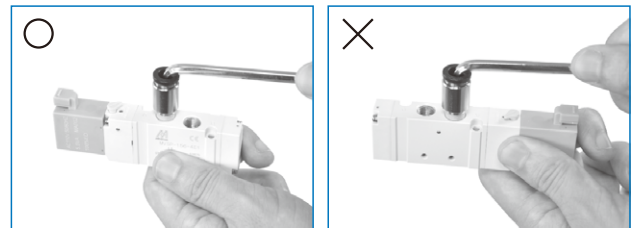

MVSP-220 Dimensions

SOLENOID VALVE



MVSP-220-4E1

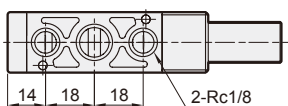
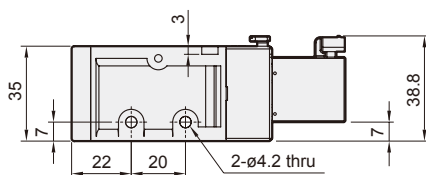
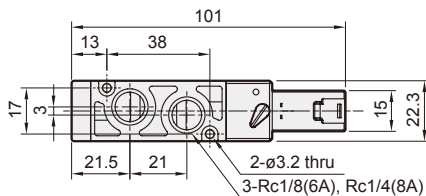
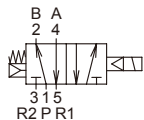

MVSP-220-4E2

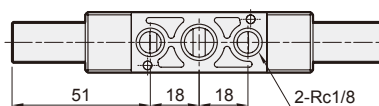
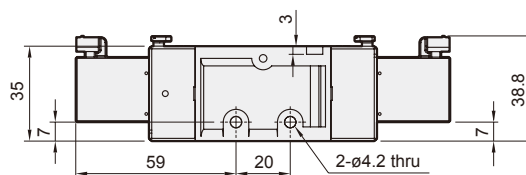
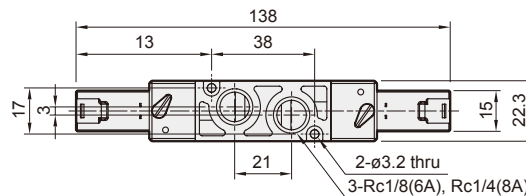
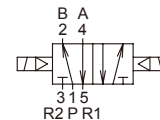

MVSP-220-4E2C.PR

MVSP-220-4E2C

MVSP-220-4E2P

MVSP-220-4E2R

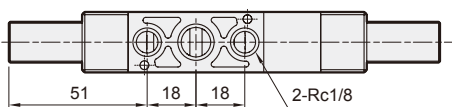
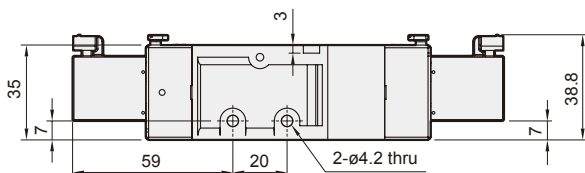
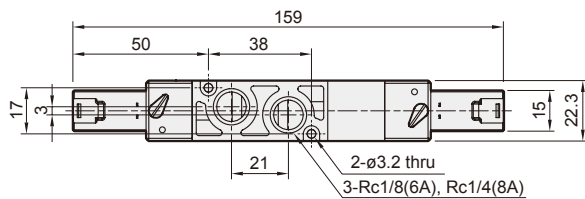
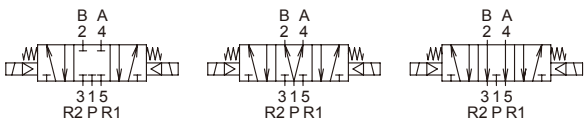

Flow features

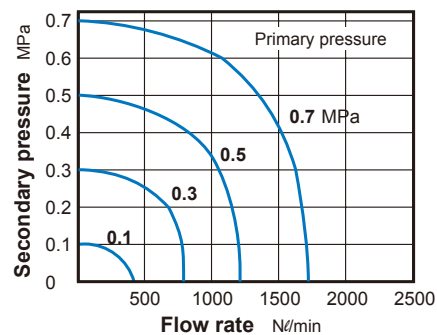

MVSP-220 Dimensions

SOLENOID VALVE



MVSP-220-3E1-NC/NO

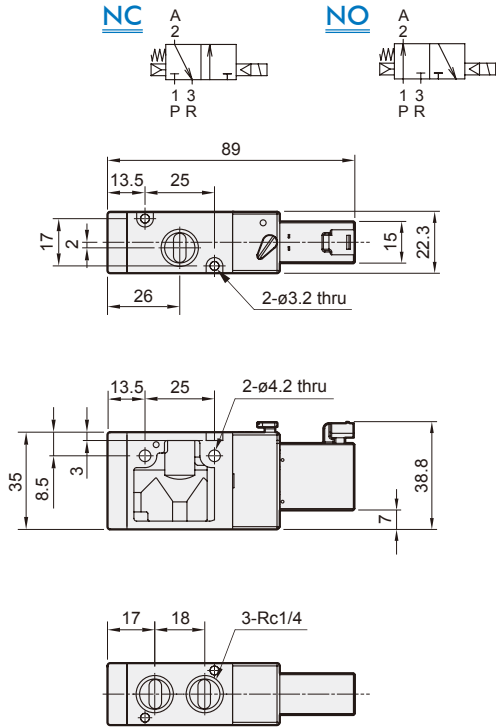

MVSP-220-3E2

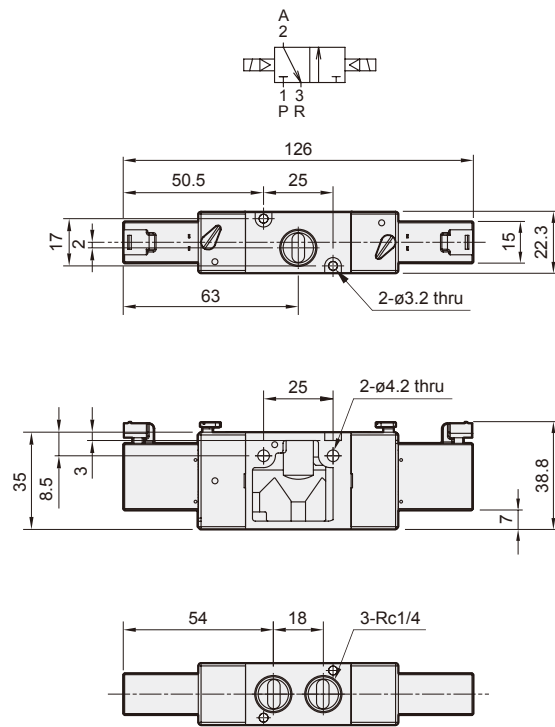

MVSC-220-3B*

3 port (for body ported type)

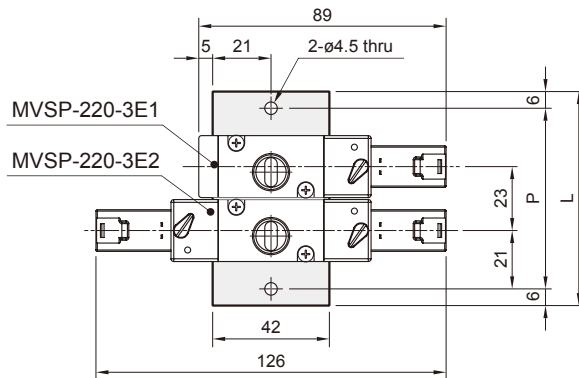

No. of stations	P	L
2	65	77
3	88	100
4	111	123
5	134	146
6	157	169
7	180	192
8	203	215
9	226	238
10	249	261

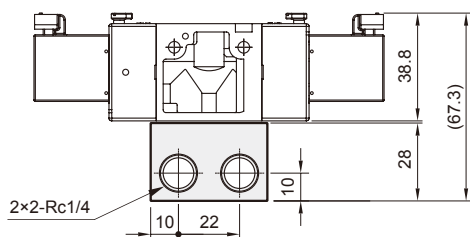

MVSP-220 Manifold

SOLENOID VALVE



MVSC-220-5B*

5 port (for body ported type)

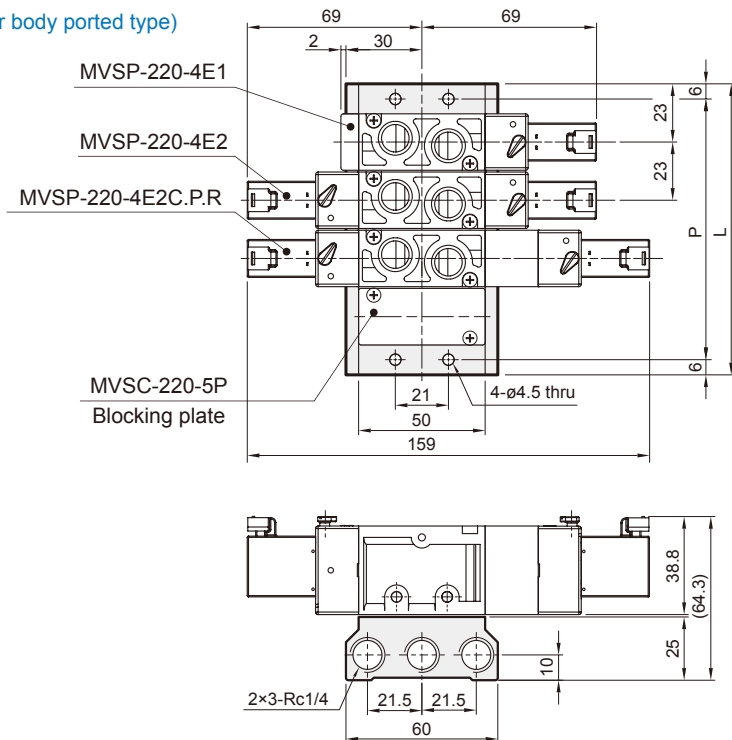

No. of stations	P	L
2	57	69
3	80	92
4	103	115
5	126	138
6	149	161
7	172	184
8	195	207
9	218	230
10	241	253

MVSC-220M-5M*

5 port (for manifold type)

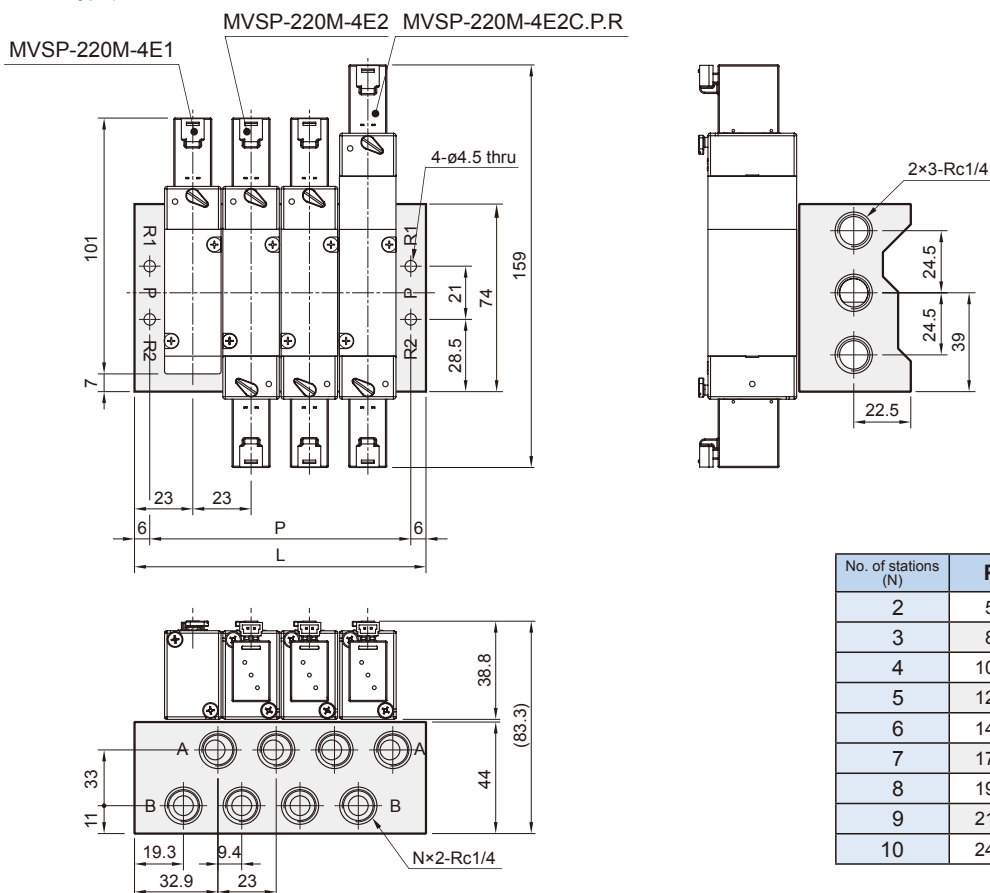

No. of stations (N)	P	L
2	57	69
3	80	92
4	103	115
5	126	138
6	149	161
7	172	184
8	195	207
9	218	230
10	241	253