

MVAA-460 series

PILOT VALVE



Specification

Model	3A1	3A2	4A1	4A2	4A2C.PR
Bore No.	15A				
Port size	G1/2				
No. of port	3		5		
Medium	Air				
Operating pressure range	0~0.8 MPa				
Proof pressure	1 MPa				
Effective orifice	50 mm ²				
Pilot pressure range	(0.34×P*+0.1)~0.8 MPa				
Ambient temperature	-5~+60°C (No freezing)				
Weight	300 g	326 g	275 g	338 g	410 g

* P: Operating pressure.

Order example

MVAA - 460 - 4A2C - NC - NPT

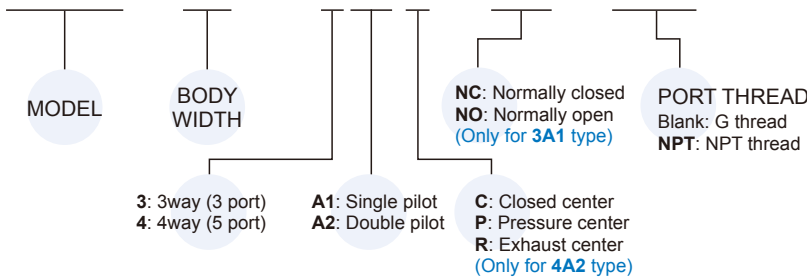

Flow features

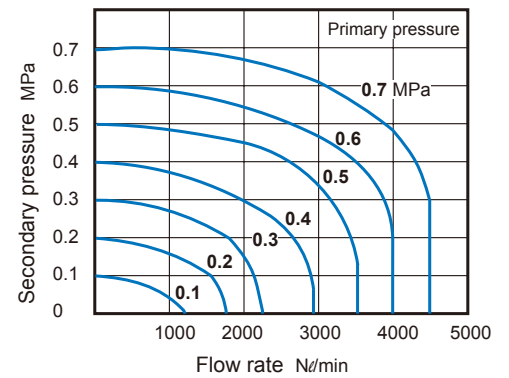

MVAA-460-3A1-NC/NO

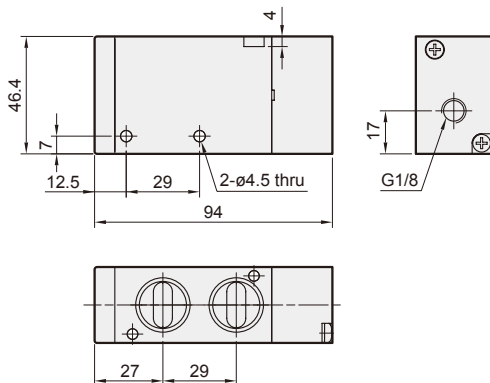
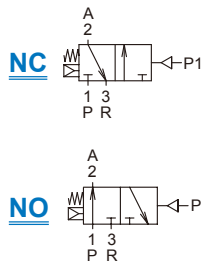
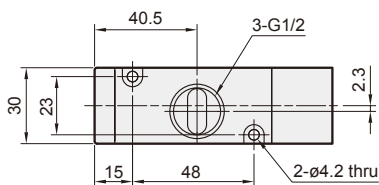

MVAA-460-3A2

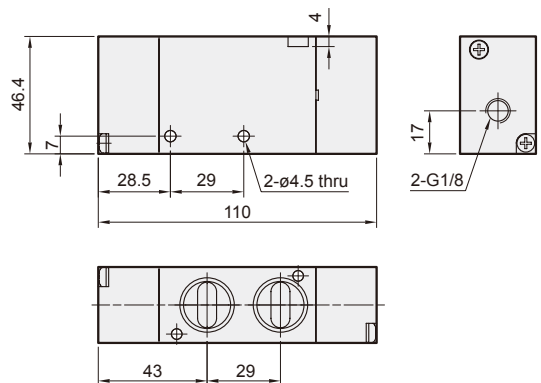
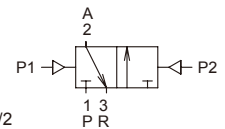
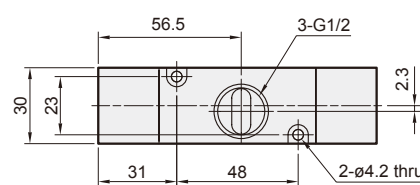

MVAA-460 Dimensions

PILOT VALVE



MVAA-460-4A1

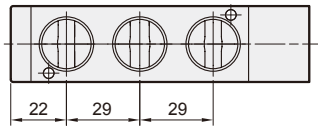
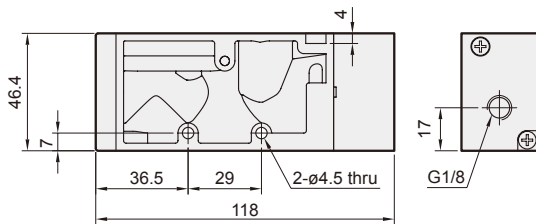
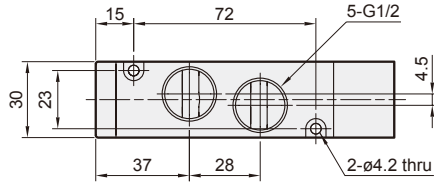
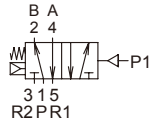

MVAA-460-4A2

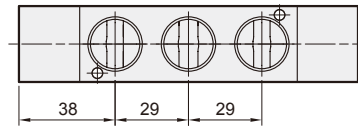
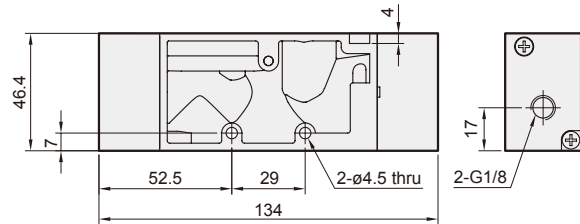
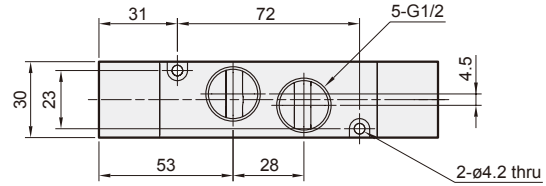
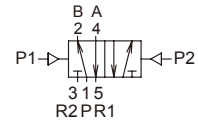

MVAA-460-4A2C.PR

MVAA-460-4A2C

MVAA-460-4A2P

MVAA-460-4A2R

