

MSC200 / 300 series

FLOW CONTROL VALVE

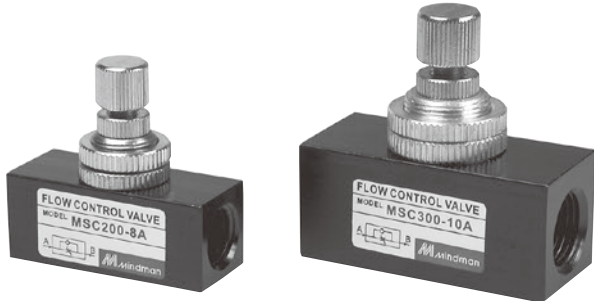

Mindman



Symbol

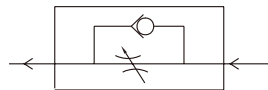

Order example

MSC200 – 6A – G

MODEL
MSC200
MSC300

PORT SIZE
6A: Rc1/8
8A: Rc1/4
10A: Rc3/8
15A: Rc1/2

PORT THREAD
Blank: Rc thread
G: G thread
NPT: NPT thread

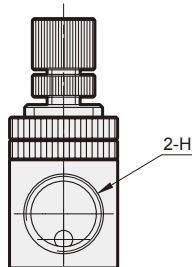
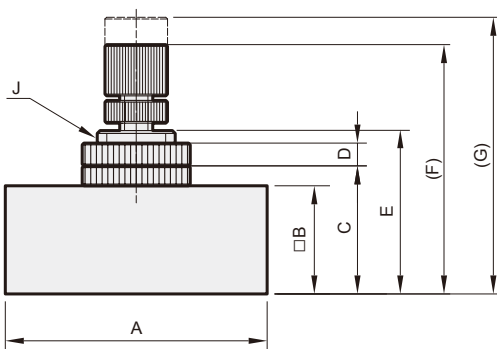
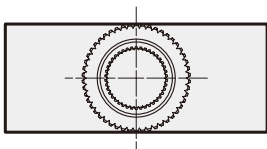

Specification

Model	MSC200		MSC300		
	6A	8A	10A	15A	
Bore No.	6A	8A	10A	15A	
Port size	Rc1/8	Rc1/4	Rc3/8	Rc1/2	
Medium	Air				
Operating pressure range	0~1 MPa				
Proof pressure	1.5 MPa				
Ambient temperature	-5~+60°C (No freezing)				
Flow (ℓ/min)	Free flow	200	200	400	430
	Controlled flow	150	100	300	400
Number of needle rotations	8		9		
Weight	72 g		130 g		

* Supply pressure: 0.5 MPa, Temperature: 20°C

Flow features

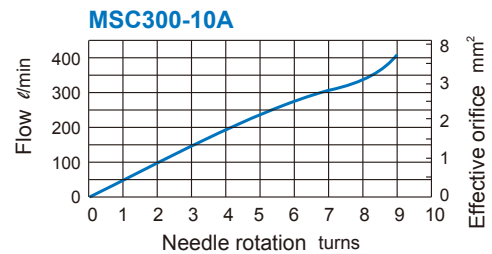
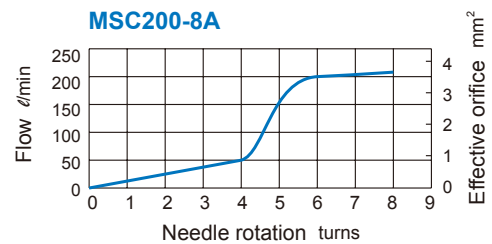

Code Model	A	B	C	D	E	F	G	H	J	
MSC200	6A	46	19	22.5	4	28.7	43.8	48.6	Rc1/8	M14×1.25
	8A	46	19	22.5	4	28.7	43.8	48.6	Rc1/4	M14×1.25
MSC300	10A	56	25.4	30	4	37	53.7	62.5	Rc3/8	M18×1.0
	15A	56	25.4	30	4	37	53.7	62.5	Rc1/2	M18×1.0