

Series 90 stainless steel cylinders

Single- and double-acting, cushioned, magnetic
 ø 32, 40, 50, 63, 80, 100 and 125 mm



- » In compliance with ISO 15552 standards and with the previous DIN/ISO 6431/VDMA 24562 standards
- » Clean design
- » Stainless steel AISI 316
- » End-stroke cushioning

Series 90 cylinders are suitable for use in harsh environmental conditions as in the offshore, naval, pharmaceutical, nuclear and food industries.

This series of cylinders is normally equipped with end of stroke buffers with adjustable pneumatic cushioning. Moreover, they are equipped with a mechanical cushioning that makes the impact of the piston less noisy as it reaches the end of the stroke.

GENERAL DATA

Construction	with tie-rods
Operation	single-acting or double-acting
Materials	- end blocks, barrel and rod in stainless steel AISI 316 - seals in NBR - plastic guiding element, NSF H1-certified lubricant
Mountings	several types of cylinders mounting brackets available
Stroke	25 ÷ 800 mm
Operating temperature	0°C ÷ 80°C (with dry air - 20°C)
Operating pressure	1 ÷ 10 bar
Speed	10 ÷ 1000 mm/sec (no load)
Media	Filtered air, without lubrication. If lubricated air is used, it is recommended to use oil ISOVG32. Once applied the lubrication should never be interrupted.

STANDARD STROKES FOR CYLINDER SERIES 90

✕ = Double-acting
 • = Single-acting

STANDARD STROKES													
Ø	25	50	80	100	125	150	160	200	250	300	320	400	500
32	✕•	✕•	✕	✕	✕	✕	✕	✕	✕	✕	✕	✕	✕
40	✕•	✕•	✕	✕	✕	✕	✕	✕	✕	✕	✕	✕	✕
50	✕•	✕•	✕	✕	✕	✕	✕	✕	✕	✕	✕	✕	✕
63	✕•	✕•	✕	✕	✕	✕	✕	✕	✕	✕	✕	✕	✕
80	✕•	✕•	✕	✕	✕	✕	✕	✕	✕	✕	✕	✕	✕
100	✕•	✕•	✕	✕	✕	✕	✕	✕	✕	✕	✕	✕	✕
125		✕•	✕	✕	✕	✕	✕	✕	✕	✕	✕	✕	✕

CODING EXAMPLE

90	M	2	A	050	A	0200	
90	SERIES						
M	VERSION M = standard, magnetic						
2	OPERATION 1 = single-acting, front spring 2 = double-acting, front and rear cushions 6 = double-acting, through-rod, front and rear cushions				PNEUMATIC SYMBOLS CS06 CD09 CD13		
A	MATERIALS A = stainless steel AISI 316, seals in NBR V = stainless steel AISI 316, all seals in FKM (150°C)						
050	BORE 032 = 32 mm - 040 = 40 mm - 050 = 50 mm - 063 = 63 mm 080 = 80 mm - 100 = 100 mm - 125 = 125 mm						
A	TYPE OF DESIGN A = standard with piston rod lock nut Mod. U						
0200	STROKE (see the table)						
	= standard V = rod seal in FKM						

PNEUMATIC SYMBOLS

The pneumatic symbols which have been indicated in the CODING EXAMPLE are shown below.

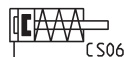
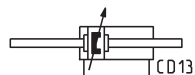
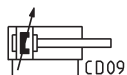

ACCESSORIES FOR STAINLESS STEEL CYLINDERS SERIES 90

Foot mount Mod. B

 Front and rear flange
Mod. D-E

 Rear trunnion, female
Mod. C-H

 Rear trunnion, male
Mod. L

 Tight rear female tr.
bracket Mod. CR

 Male tr. bracket with
swivel ball joint Mod. R

 90° male tr. bracket + sw.
ball joint Mod. ZCR

 90° male trunnion
Mod. ZC

Rod fork end Mod. G-90



Clevis pin Mod. S-90

 Anti-rotation clevis pin
Mod. SR-90

 Swivel ball joint
Mod. GA-90

 Piston rod lock nut
Mod. U-90

All accessories are supplied separately, except for the piston rod lock nut Mod. U

Cylinders Series 90



+ = add the stroke

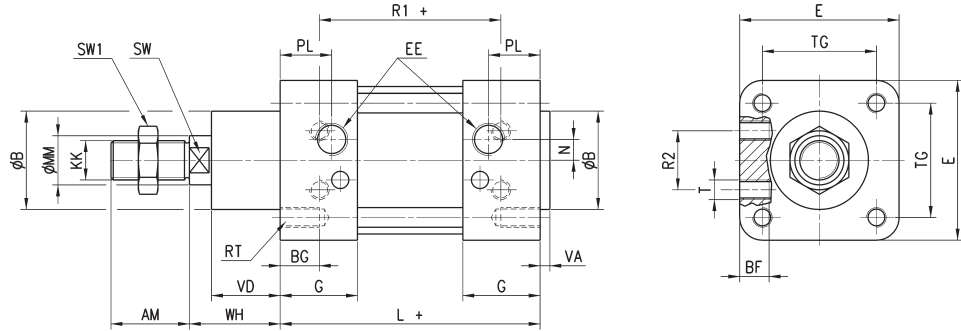

DIMENSIONS

Ø	AM	B	BF	BG	E	EE	G	KK	L	MM	N	PL	RT	R1	R2	SW	SW1	T	TG	VA	VD	WH
32	22	30	10	16	45	G1/8	28	M10x1.25	94	12	4.5	14	M6	64	16	10	17	M5	32.5	4	20	26
40	24	35	10	16	55	G1/4	31.5	M12x1.25	105	16	5.5	16	M6	70	21	13	19	M6	38	4	22	30
50	32	40	12	16	65	G1/4	31.5	M16x1.5	106	20	8.5	21	M8	74	24	17	24	M8	46.5	4	28	37
63	32	45	12	16	80	G3/8	35	M16x1.5	121	20	8.5	22	M8	85	33	17	24	M8	56.5	4	28	37
80	40	45	15	16	95	G3/8	36	M20x1.5	128	25	8.5	23	M10	92	34	21	30	M10	72	4	34	46
100	40	55	15	16	115	G1/2	41	M20x1.5	138	25	10	26	M10	100	58	21	30	M10	89	4	38	51
125	54	60	24	20	140	G1/2	45	M27x2	160	32	12.5	30	M12	110	65	27	41	M12	110	5	50	65

Cylinders Series 90 - through-rod



+ = add the stroke once
++ = add the stroke twice

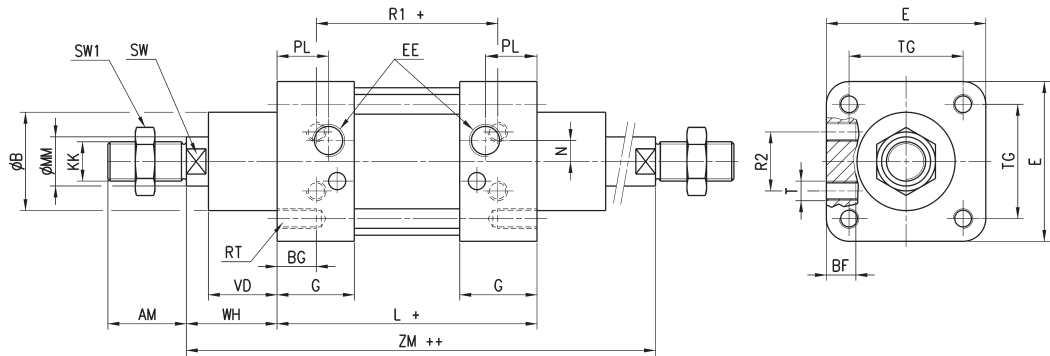

DIMENSIONS

Ø	AM	B	BF	BG	E	EE	G	KK	L	MM	N	PL	RT	R1	R2	SW	SW1	T	TG	VD	WH	ZM
32	22	30	10	16	45	G1/8	28	M10x1.25	94	12	4.5	14	M6	64	16	10	17	M5	32.5	20	26	146
40	24	35	10	16	55	G1/4	31.5	M12x1.25	105	16	5.5	16	M6	70	21	13	19	M6	38	22	30	165
50	32	40	12	16	65	G1/4	31.5	M16x1.5	106	20	8.5	21	M8	74	24	17	24	M8	46.5	28	37	180
63	32	45	12	16	80	G3/8	35	M16x1.5	121	20	8.5	22	M8	85	33	17	24	M8	56.5	28	37	195
80	40	45	15	16	95	G3/8	36	M20x1.5	128	25	8.5	23	M10	92	34	21	30	M10	72	34	46	220
100	40	55	15	16	115	G1/2	41	M20x1.5	138	25	10	26	M10	100	58	21	30	M10	89	38	51	240
125	54	60	24	20	140	G1/2	45	M27x2	160	32	12.5	30	M12	110	65	27	41	M12	110	50	65	290

Foot mount Mod. B

Material: stainless steel 316

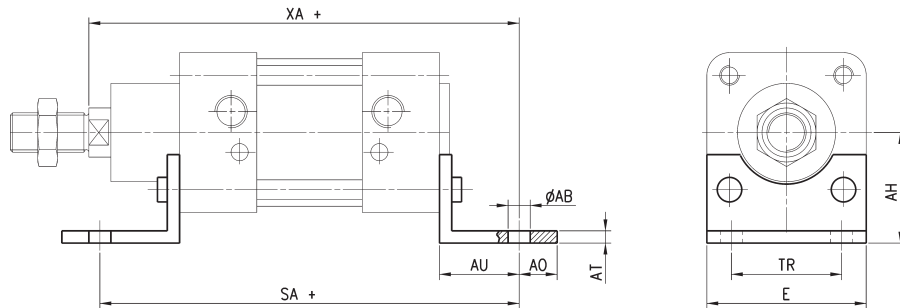

Supplied with:
2x feet
4x screws
+ = add the stroke

DIMENSIONS

Mod.	Ø	ØAB	AH	AO	AT	AU	E	TR	SA+	XA+
B-90-32	32	7	32	11	4	24	45	32	142	144
B-90-40	40	9	36	8	4	28	52	36	161	163
B-90-50	50	9	45	15	5	32	65	45	170	175
B-90-63	63	9	50	13	5	32	75	50	185	190
B-90-80	80	12	63	14	6	41	95	63	210	215
B-90-100	100	14	75	16	6	41	115	75	220	230
B-90-125	125	16	90	25	8	45	140	90	250	270

Front and rear flange Mod. D-E

Material: stainless steel 316

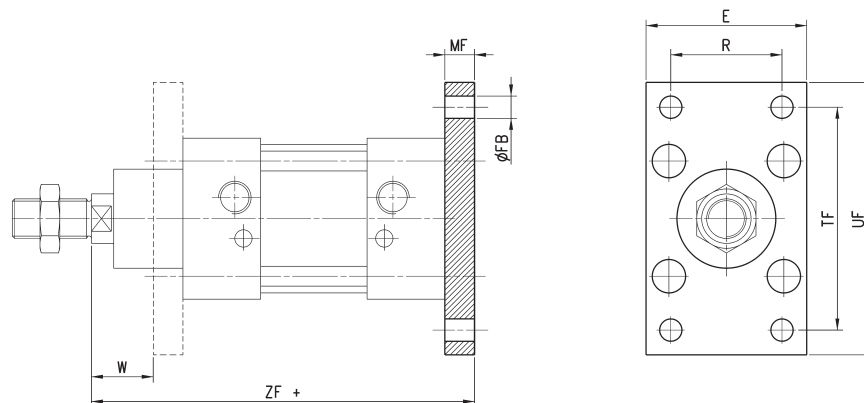

Supplied with:
1x flange
4x screws
+ = add the stroke

DIMENSIONS

Mod.	Ø	E	ØFB	MF	TF	UF	W	ZF+	R
D-E-90-32	32	45	7	10	64	80	16	130	32
D-E-90-40	40	52	9	10	72	90	20	145	36
D-E-90-50	50	65	9	12	90	110	25	155	45
D-E-90-63	63	75	9	12	100	120	25	170	50
D-E-90-80	80	95	12	15	126	150	30	190	63
D-E-90-100	100	115	14	15	150	170	35	205	75
D-E-90-125	125	140	16	20	180	205	45	245	90

Rear trunnion, female Mod. C-H

Material: stainless steel 316



Supplied:
1x female trunnion
4x screws

+ = add the stroke

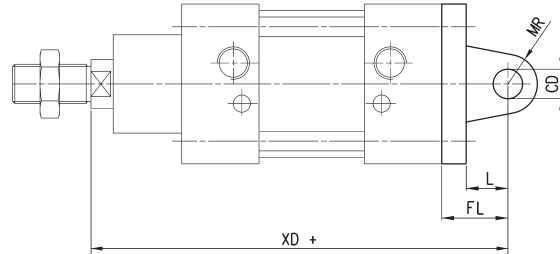
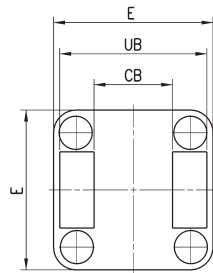

DIMENSIONS

Mod.	∅	CB	CD	E	FL	L	MR	UB	XD+
C-H-90-32	32	26	10	45	22	12	10	45	142
C-H-90-40	40	28	12	55	25	15	12	52	161
C-H-90-50	50	32	12	65	27	17	12	60	170
C-H-90-63	63	40	16	75	32	20	16	70	185
C-H-90-80	80	50	16	95	36	22	16	90	210
C-H-90-100	100	60	20	115	41	25	20	110	230
C-H-90-125	125	70	25	140	50	30	25	130	275

Rear trunnion, male Mod. L

Material: stainless steel 316



Supplied:
1x male trunnion
4x screws

+ = add the stroke

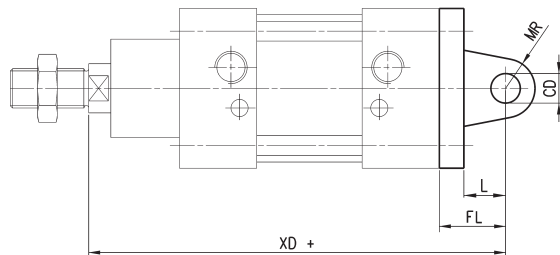
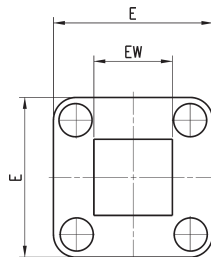

DIMENSIONS

Mod.	∅	EW	CD	E	FL	L	MR	XD+
L-90-32	32	26	10	45	22	12	10	142
L-90-40	40	28	12	55	25	15	12	161
L-90-50	50	32	12	65	27	17	12	170
L-90-63	63	40	16	75	32	20	16	185
L-90-80	80	50	16	95	36	22	16	210
L-90-100	100	60	20	115	41	25	20	230
L-90-125	125	70	25	140	50	30	25	275

Tight rear female trunnion bracket Mod. CR

Material: stainless steel 316

 Supplied with:
 1x female trunnion bracket
 4x screws

+ = add the stroke

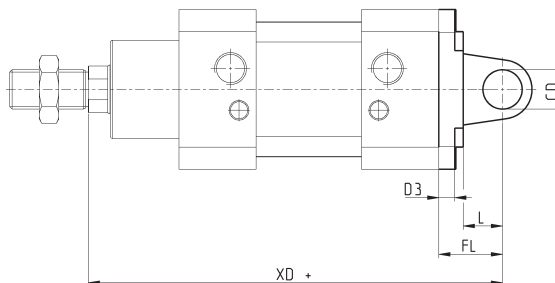
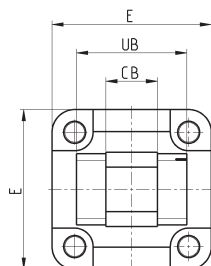
DIMENSIONS

Mod.	Ø	CB	CD	E	FL	L	UB	XD	D3
CR-90-32	32	14	10	45	22	12	34	142	5.5
CR-90-40	40	16	12	55	25	25	40	161	5.5
CR-90-50	50	21	16	65	27	27	45	170	6.5
CR-90-63	63	21	16	75	32	32	51	185	6.5
CR-90-80	80	25	20	95	36	36	65	210	10
CR-90-100	100	25	20	114	41	41	75	230	10
CR-90-125	125	37	30	140	50	50	97	275	10

Male trunnion bracket with swivel ball joint Mod. R

Material: stainless steel 316

 Supplied with:
 1x male trunnion bracket
 4x screws

+ = add the stroke

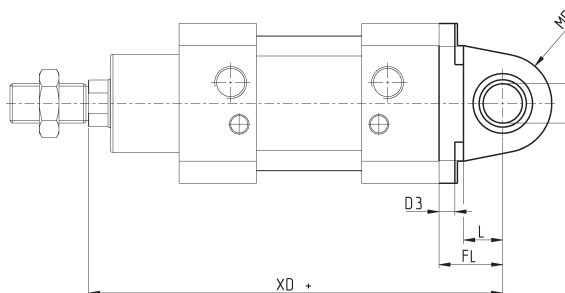
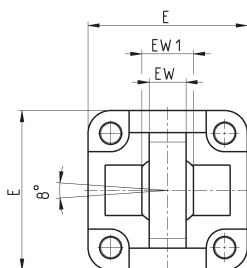
DIMENSIONS

Mod.	Ø	EW	EW1	CD	E	FL	L	MR	XD	D3
R-90-32	32	10.5	14	10	45	22	12	15	142	5.5
R-90-40	40	12	16	12	55	25	15	18	161	5.5
R-90-50	50	15	21	16	65	27	17	20	170	6.5
R-90-63	63	15	21	16	75	32	20	23	185	6.5
R-90-80	80	18	25	20	95	36	22	27	210	10
R-90-100	100	18	25	20	115	41	25	30	230	10
R-90-125	125	25	37	30	140	50	30	40	275	10

90° male trunnion bracket with swivel ball joint Mod. ZCR

Material: stainless steel 316



Supplied with:
1x male trunnion bracket
4x screws

+ = add the stroke

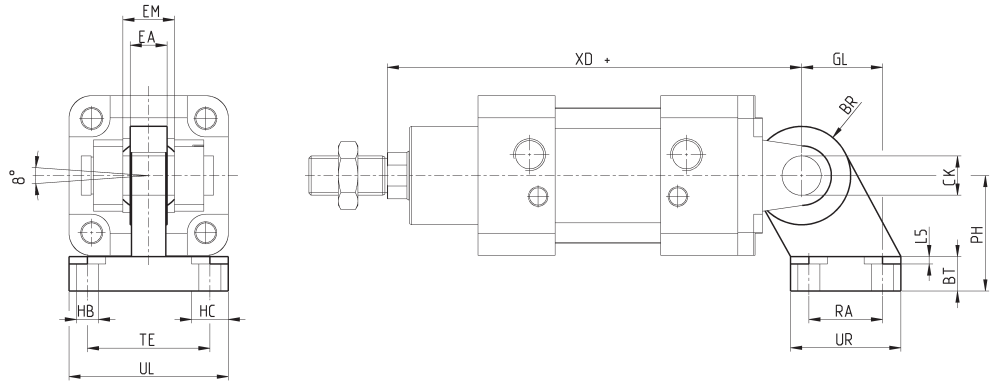

DIMENSIONS

Mod.	∅	UL	TE	EA	EM	XD	GL	BR	CK	PH	L5	BT	HB	RA	UR	HC
ZCR-90-32	32	51	38	10.5	14	142	21	15	10	32	1.5	10	6.6	18	31	11
ZCR-90-40	40	54	41	12	16	160	24	18	12	36	1.5	10	6.6	22	35	11
ZCR-90-50	50	65	50	15	21	170	33	20	16	45	1.5	12	9	30	45	15
ZCR-90-63	63	67	52	15	21	190	37	23	16	50	1.5	12	9	35	50	15
ZCR-90-80	80	86	66	18	25	210	47	27	20	63	2.5	14	11	40	60	18
ZCR-90-100	100	96	76	18	25	230	55	30	20	71	2.5	15	11	50	70	18
ZCR-90-125	125	124	94	25	37	275	70	40	30	90	3	20	13.5	60	90	20

90° male trunnion Mod. ZC

Material: stainless steel 316



Supplied with:
1x male support

+ = add the stroke

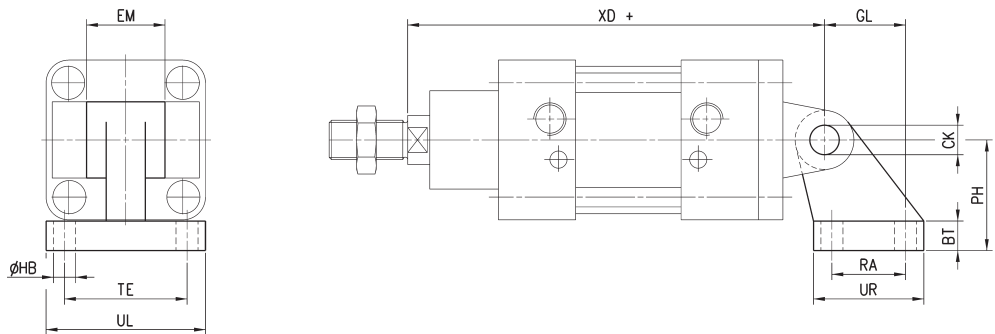

DIMENSIONS

Mod.	∅	BT	CK	EM	GL	∅HB	PH	RA	TE	UL	UR	XD+
ZC-90-32	32	8	10	26	21	6,6	32	18	38	51	31	142
ZC-90-40	40	10	12	28	24	6,6	36	22	41	54	35	161
ZC-90-50	50	12	12	32	33	9	45	30	50	65	45	170
ZC-90-63	63	12	16	40	37	9	50	35	52	67	50	185
ZC-90-80	80	14	16	50	47	11	63	40	66	86	60	210
ZC-90-100	100	15	20	60	55	11	71	50	76	96	70	230
ZC-90-125	125	20	25	70	70	14	90	60	94	124	90	275

Rod fork end Mod. G-90

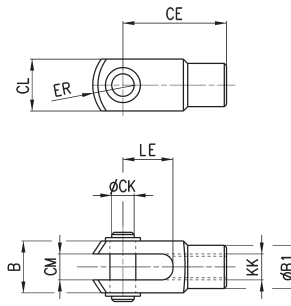
 Material: stainless steel 303
 ISO 8140

DIMENSIONS

Mod.	Ø	ØCK	LE	CM	CL	ER	CE	KK	B	ØB1
G-90-25-32	32	10	20	10	20	12	40	M10x1,25	26	18
G-90-40	40	12	24	12	24	14	48	M12x1,25	31	20
G-90-50-63	50-63	16	32	16	32	19	64	M16x1,5	39	26
G-90-80-100	80-100	20	40	20	40	25	80	M20x1,5	50	34
G-90-125	125	30	54	30	55	38	110	M27x2	67	48

Clevis pin Mod. S-90

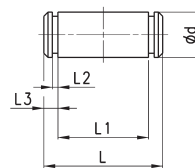
Material: stainless steel 303

DIMENSIONS

Mod.	Ø	Ød	L	L1	L2	L3
S-90-32	32	10	53	46	1,1	3
S-90-40	40	12	60	53	1,1	3
S-90-50	50	12	68	61	1,1	3
S-90-63	63	16	78	71	1,1	3
S-90-80	80	16	98	91	1,1	3
S-90-100	100	20	118	111	1,3	5
S-90-125	125	25	139	132	1,3	4,2

Antirotating clevis pin Mod. SR-90

Supplied with:
 1x antirotating clevis pin
 (stainless steel 316)
 1x seeger (steel)

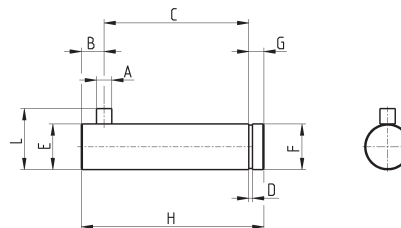

DIMENSIONS										
Mod.	Ø	A	B	C	D	E	F	G	H	L
SR-90-32	32	3	4.5	32.5	1.1	10	9.6	4	41	14
SR-90-40	40	4	6	38	1.1	12	11.5	4	48	46
SR-90-50	50	4	6	43	1.1	16	15.2	5	54	20
SR-90-63	63	4	6	49	1.1	16	15.2	5	60	20

Swivel ball joint Mod. GA-90

ISO 8139

Materials:
 - stainless steel 304 bracket
 - stainless steel 420 spherical ring
 - sintered bronze bushing

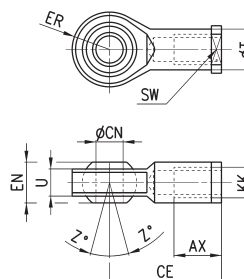

DIMENSIONS											
Mod.	Ø	ØCN	U	EN	ER	AX	CE	KK	ØT	Z	SW
GA-90-32	32	10	10,5	14	14	20	43	M10x1,25	15	6,5	17
GA-90-40	40	12	12	16	16	22	50	M12x1,25	17,5	6,5	19
GA-90-50-63	50-63	16	15	21	21	28	64	M16x1,5	22	7,5	22
GA-90-80-100	80-100	20	18	25	21	33	77	M20x1,5	27,5	7	30
GA-90-125	125	30	25	35	35	51	110	M27x2	40	7,5	41

Piston rod lock nut Mod. U-90

ISO 4035

Material: stainless steel 304

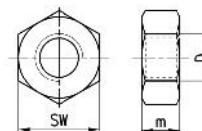

DIMENSIONS				
Mod.	Ø	D	m	SW
U-90-25-32	32	M10x1,25	6	17
U-90-40	40	M12x1,25	7	19
U-90-50-63	50-63	M16x1,5	8	24
U-90-80-100	80-100	M20x1,5	9	30
U-90-125	125	M27x2	12	41