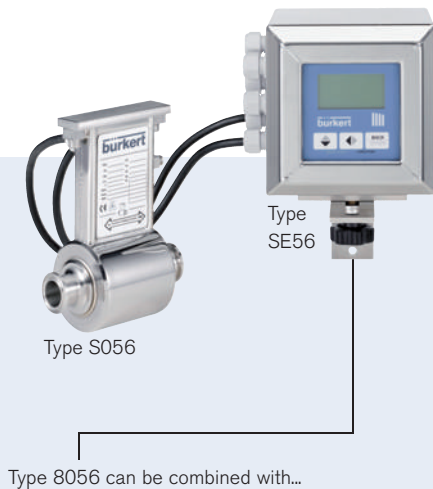
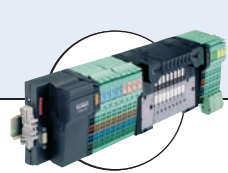

Electromagnetic Flowmeter, full bore - Sanitary version

**Type 6223**

Solenoid control valve

**Type 8801-YE**Element
On/Off system**Type 8802-DD**Classic
Continuous system**Type 8644**

Valve islands

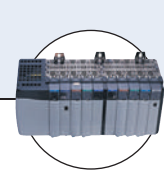
**PLC**

- Combination of sensor fitting S056 and electronics SE56
- Continuous measurement or Batch Control
- Sanitary version,  certificate
- Dedicated to food & beverage or pharmaceutical applications

The complete full bore magmeter Type 8056, which consists of a magnetic sensor fitting Type S056 connected to an electronics Type SE56 (blind in compact version or with display in compact or remote version) is designed for applications with liquids with a minimum conductivity of 5 $\mu\text{S}/\text{cm}$.

Combined with a valve as the actuating element, the complete flowmeter Type 8056 can control high-precision dosing operations and flow measurement in food & beverage or pharmaceutical industry.

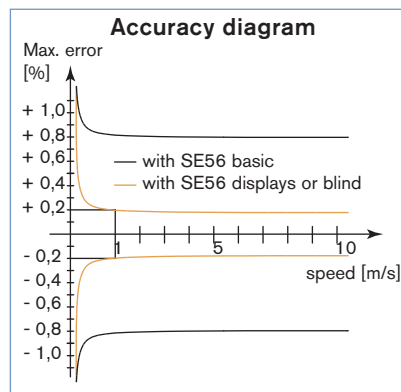

General data - S056 sensor fitting

Compatibility	SE56 electronics (see corresponding data sheet)
Materials	
Body	Stainless steel 304
Electrodes (2 in standard)	Stainless steel 316L
Lining	PTFE
Seal	FKM or EPDM* (FDA approved)
Electrical connection	2 cable glands PG9

Data complete flowmeter 8056 - (S056 sensor fitting + SE56 electronics)

Pipe diameter	DN03 to DN100
Measuring range	0... 10 l/h to 0... 280 m ³ /h
Process connection	DIN11851, Clamp ISO2852 or Clamp BS4825 [SMS (from DN10)]*
Medium temperature	see medium temperature chart on page 3 go to page
Medium pressure max.	PN16 (232 PSI)
Vacuum resistance	200 mbar (2.9 PSI) absolute at 100°C (212°F)
Accuracy ¹⁾	$\pm 0.2\%$ of reading (SE56 standard; SE56 blind) see diagram, opposite $\pm 0.8\%$ of reading (SE56 basic)
Repeatability	$\pm 0.1\%$ (SE56 standard; SE56 blind) $\pm 0.2\%$ (SE56 basic)
Minimum conductivity	5 $\mu\text{S}/\text{cm}$ (or 20 $\mu\text{S}/\text{cm}$ with demineralized water)

* on request

¹⁾ under reference conditions: water temperature = 20°C, ambient temperature = 25°C, constant flow rate during the test, liquid speed > 1 m/s

Environment	
Ambient temperature with SE56 standard	-20 to 60°C (-4 to 140°F) (operating and storage)
SE56 basic	-10 to 50°C (14 to 122°F) (operating)
	-20 to 50°C (-4 to 122°F) (storage)
SE56 blind	-20 to 40°C (-4 to 104°F) (operating and storage)
Standard	
Protection class	IP65 and IP67 (compact version, SE56 standard or SE56 blind); IP65 (remote version, SE56 standard) IP68 (remote version and junction box filled with resin, SE56 standard); IP65 (compact version, SE56 basic)
Standard EMC Emission / Immunity Safety	EN 61326-1, EN 55011 (Group 1, Class B) / IEC 1000-4-2/3/4/5/6/11 EN 61010

Ordering information for complete flowmeter Type 8056

A complete flowmeter Type 8056 consists of a sensor fitting S056 and an electronics SE56.

The following information is necessary for the selection of a complete flowmeter:

- **item no.** of the sensor fitting **Type S056** (see Ordering Chart on page 6)
- **item no.** of the electronics **Type SE56** (see corresponding data sheet or Ordering chart on page 7)

More info.

For more technical information about this product, click on this box... you will come to our website for this product where you can download the datasheet.

Examples for variations of complete flowmeter (electronics + sensor fitting)

Electronics Type SE56

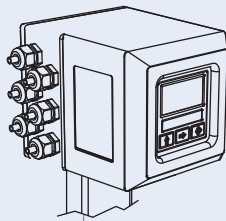

Standard with display
compact version

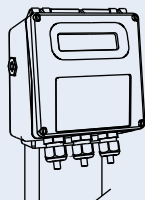

Basic (with or without display)
compact version

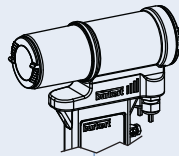

Without display (blind)
compact version

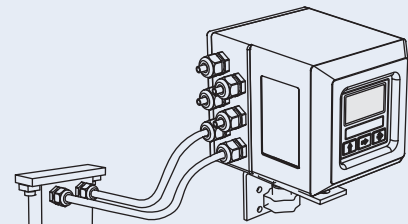

Standard with display
remote version

Sensor fitting Type S056

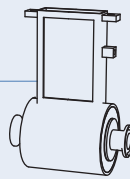

Compact version
sensor fitting

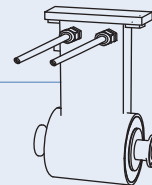

Remote version
sensor fitting

Design and operating principle

The sensor fitting Type S056 consists of a stainless steel pipe section internally lined with insulating material. Two electrodes mounted opposite to each other on the internal surface of the tube generate an electrical signal. The coils generating the magnetic field are placed outside the pipe. The signal generated by the sensor fitting S056 must be amplified and processed by an electronics (SE56) which outputs an electrical signal proportional to the fluid flow velocity respectively to the flow rate.

Faraday's induction law is the basis for this magnetic flow measurement.

Installation



Avoid the functioning with the pipe partially filled.

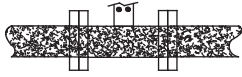

During flowmeter operation the pipe must be completely full.

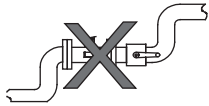

Avoid the installation near curves or hydraulic accessories.

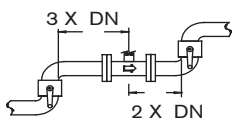

Observe the upstream and downstream distances.

The sensor fitting can be installed into either horizontal or vertical pipes. Mount the sensor fitting in the below as correct indicated ways to obtain an accurate flow measurement.

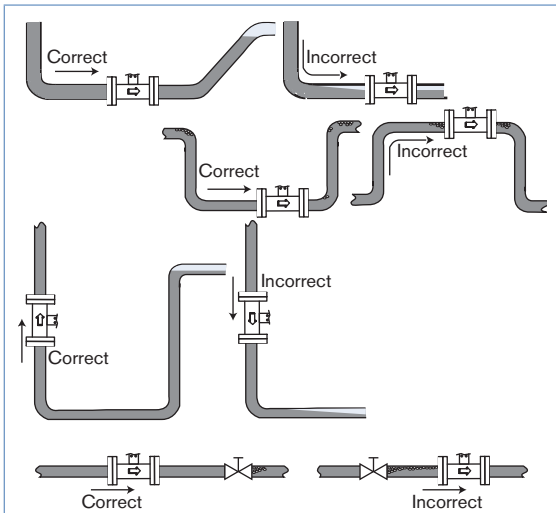

The suitable pipe size is selected using the diagram Flow/Velocity/DN (see diagram to the right).
The flow sensor fitting is not designed for gas flow measurement.

Flow/Velocity/DN diagram



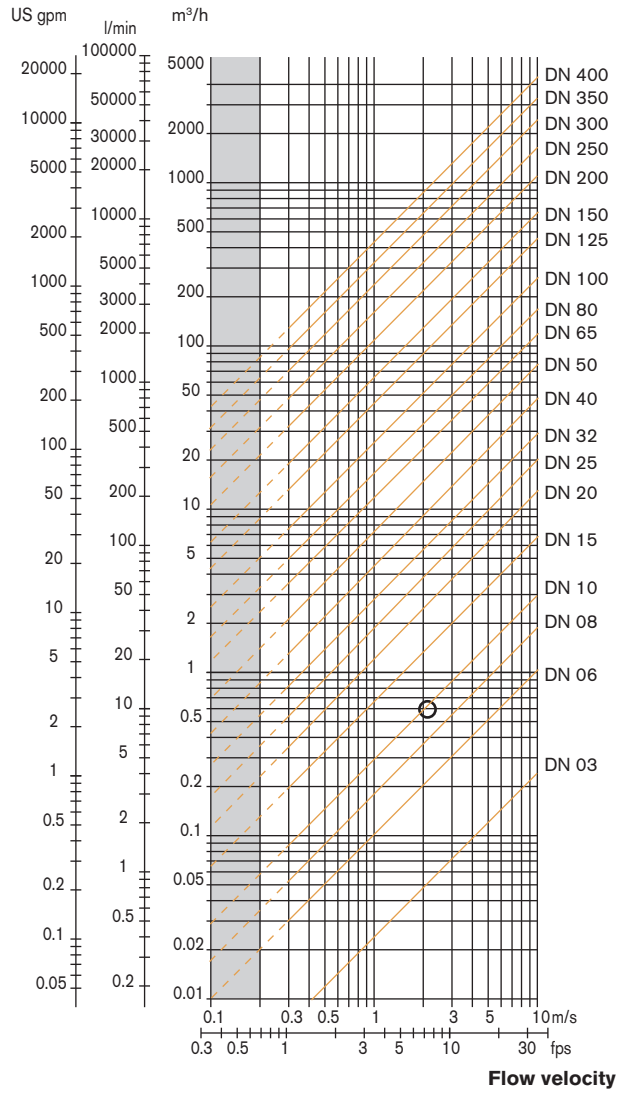

Example:

- Flow: 0.6 m³/h
- Ideal flow velocity: 2... 3 m/s
- For these specifications, the diagram indicates a pipe size of DN10

Flow rate



Medium temperature chart

	SE56 standard compact 	SE56 standard remote 	SE56 basic compact 	SE56 blind compact 
 S056 Sensor fitting	-20 to 100°C (-4 to 212°F)	-20 to 130°C (-4 to 266°F)	-10 to 100°C (14 to 212°F)	-20 to 100°C (-4 to 212°F) [up to 130°C (up to 266°F) for max. 1 hour]

Dimensions [mm] of Type S056 sensor fitting - sanitary version DIN 11851

NOTE: Dimensions of SE56 electronics, see corresponding data sheet.

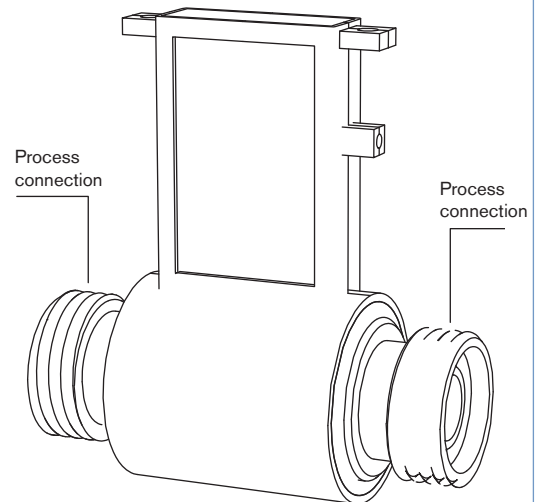
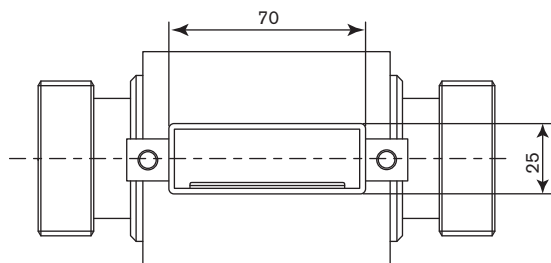
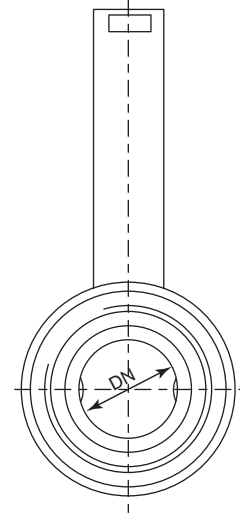
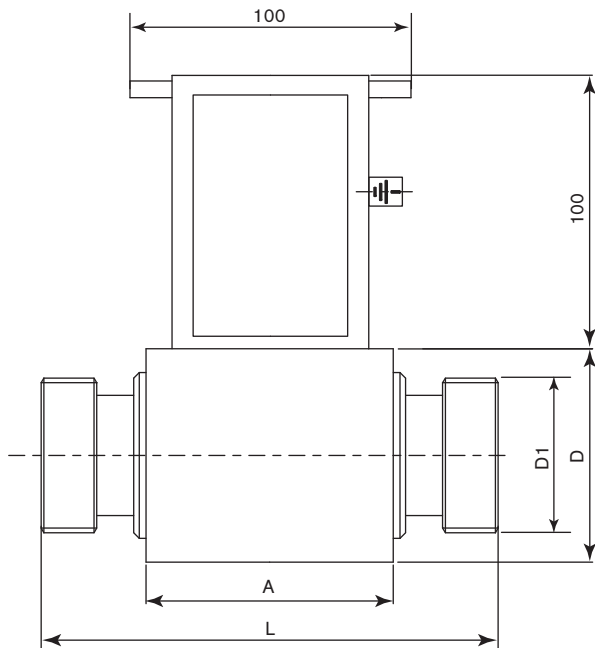

DN	A	L	D	Process connection	D1
03	77	128	76	DN10	RD28 x 1/8
06	77	128	76	DN10	RD28 x 1/8
10	77	128	76	DN10	RD28 x 1/8
15	77	128	76	DN15	RD34 x 1/8
20	77	128	76	DN20	RD44 x 1/6
25	100	180	76	DN25	RD52 x 1/6
32	100	180	89	DN32	RD58 x 1/6
40	100	180	89	DN40	RD65 x 1/6
50	100	180	114	DN50	RD78 x 1/6
65	100	180	140	DN65	RD95 x 1/6
80	100	200	140	DN80	RD110 x 1/4
100	100	200	168	DN100	RD130 x 1/4

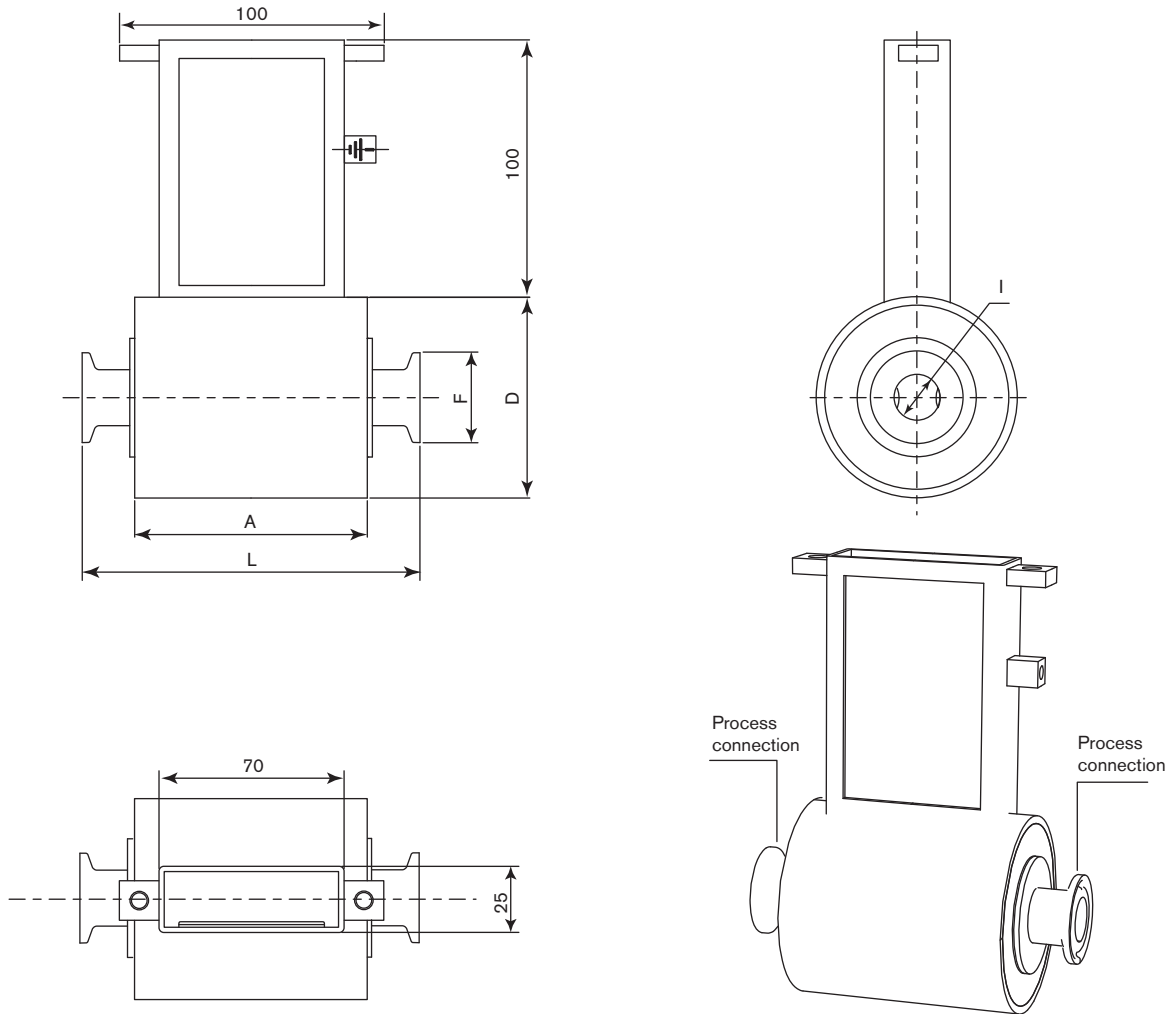
Dimensions [mm] of Type S056 sensor fitting - sanitary version Clamp ISO2852 or BS4825
NOTE: Dimensions of SE56 electronics, see corresponding data sheet.

DN	A	L	D	Standard	F	I
03	77	128	76	Clamp ISO2852	34	12.7
				Clamp BS4825	25.4	9.5
06	77	128	76	Clamp ISO2852	34	12.7
				Clamp BS4825	25.4	9.5
10	77	128	76	Clamp ISO2852	34	12.7
				Clamp BS4825	25.4	9.5
15	77	128	76	Clamp ISO2852	34	17.2
				Clamp BS4825	25.4	15.85
20	77	128	76	Clamp ISO2852	34	21.3
				Clamp BS4825	50.5	22.2
25	100	180	76	Clamp ISO2852	50.5	22.6
				Clamp BS4825	50.5	22.2
40	100	180	89	Clamp ISO2852	50.5	35.6
				Clamp BS4825	50.5	34.9
50	100	180	114	Clamp ISO2852	64	48.6
				Clamp BS4825	64	47.6
65	100	180	140	Clamp ISO2852	77.5	60.3
				Clamp BS4825	77.5	60.3
80	100	200	140	Clamp ISO2852	91	72.9
				Clamp BS4825	91	72.9
100	100	200	180	Clamp ISO2852	119	97.6
				Clamp BS4825	119	97.6

Ordering chart for sanitary flowmeter 8056

A complete flowmeter Type 8056 consists of:

- a sensor fitting, sanitary version Type S056
- an electronics Type SE56

Please order the relevant sensor fitting and the electronics separately!

Sensor fitting Type S056

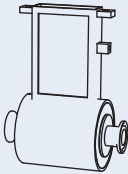
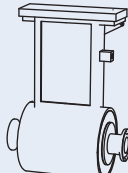
Description	DN [mm]	Flow rate range		Body material	Number of electrodes	Electrode material	Material: Lining/Seal	Process connection	Item no.
		min. 0... 0.4 m/s	max. 0... 10 m/s						
Compact version 	03	0... 10 [l/h]	0... 250 [l/h]	SS 304	2	SS 316L	PTFE/FKM	DIN 11851	555 732
								Clamp ISO2852	554 004
								Clamp BS4825	559 786
	06	0... 40 [l/h]	0... 1000 [l/h]	SS 304	2	SS 316L	PTFE/FKM	DIN 11851	559 430
								Clamp ISO2852	559 431
								Clamp BS4825	553 325
	10	0... 120 [l/h]	0... 3000 [l/h]	SS 304	2	SS 316L	PTFE/FKM	DIN 11851	559 432
								Clamp ISO2852	554 904
								Clamp BS4825	554 350
	15	0... 240 [l/h]	0... 6000 [l/h]	SS 304	2	SS 316L	PTFE/FKM	DIN 11851	553 527
								Clamp ISO2852	553 555
								Clamp BS4825	553 533
	20	0... 500 [l/h]	0... 12500 [l/h]	SS 304	2	SS 316L	PTFE/FKM	DIN 11851	553 528
								Clamp ISO2852	559 433
								Clamp BS4825	553 534
	25	0... 0.72 [m³/h]	0... 18 [m³/h]	SS 304	2	SS 316L	PTFE/FKM	DIN 11851	553 486
								Clamp ISO2852	554 151
								Clamp BS4825	553 535
	32	0... 1.16 [m³/h]	0... 29 [m³/h]	SS 304	2	SS 316L	PTFE/FKM	DIN 11851	553 529
								Clamp ISO2852	553 741
Clamp BS4825								553 536	
40	0... 1.80 [m³/h]	0... 45 [m³/h]	SS 304	2	SS 316L	PTFE/FKM	DIN 11851	553 530	
							Clamp ISO2852	553 741	
							Clamp BS4825	553 536	
50	0... 2.88 [m³/h]	0... 72 [m³/h]	SS 304	2	SS 316L	PTFE/FKM	DIN 11851	553 531	
							Clamp ISO2852	555 120	
							Clamp BS4825	553 537	
65	0... 4.80 [m³/h]	0... 120 [m³/h]	SS 304	2	SS 316L	PTFE/FKM	DIN 11851	553 532	
							Clamp ISO2852	554 116	
							Clamp BS4825	553 538	
80	0... 7.20 [m³/h]	0... 180 [m³/h]	SS 304	2	SS 316L	PTFE/FKM	DIN 11851	555 089	
							Clamp ISO2852	559 434	
							Clamp BS4825	559 791	
100	0... 11.20 [m³/h]	0... 280 [m³/h]	SS 304	2	SS 316L	PTFE/FKM	DIN 11851	on request	
							Clamp ISO2852	on request	
							Clamp BS4825	on request	
Remote version with 10 m cable (included) 	03	0... 10 [l/h]	0... 250 [l/h]	SS 304	2	SS 316L	PTFE/FKM	DIN 11851	551 506
								Clamp ISO2852	551 501
								Clamp BS4825	559 787
	06	0... 40 [l/h]	0... 1000 [l/h]	SS 304	2	SS 316L	PTFE/FKM	DIN 11851	551 507
								Clamp ISO2852	551 502
								Clamp BS4825	559 788
	10	0... 120 [l/h]	0... 3000 [l/h]	SS 304	2	SS 316L	PTFE/FKM	DIN 11851	551 508
								Clamp ISO2852	551 503
								Clamp BS4825	559 759
	15	0... 240 [l/h]	0... 6000 [l/h]	SS 304	2	SS 316L	PTFE/FKM	DIN 11851	551 509
								Clamp ISO2852	551 504
								Clamp BS4825	554 082

Ordering chart for sanitary flowmeter 8056 (continued)

Sensor fitting Type S056

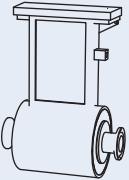
Description	DN [mm]	Flow rate range		Body material	Number of electrodes	Electrode material	Material: Lining/Seal	Process connection	Item no.	
		min. 0... 0.4 m/s	max. 0... 10 m/s							
Remote version with 10 m cable (included) 	20	0... 500 [l/h]	0... 12500 [l/h]	SS 304	2	SS 316L	PTFE/FKM	DIN 11851	551 510	
								Clamp ISO2852	551 505	
								Clamp BS4825	553 925	
	25	0... 0.72 [m³/h]	0... 18 [m³/h]	SS 304	2	SS 316L	PTFE/FKM	PTFE/FKM	DIN 11851	448 480
									Clamp ISO2852	448 499
									Clamp BS4825	559 789
	32	0... 1.16 [m³/h]	0... 29 [m³/h]	SS 304	2	SS 316L	PTFE/FKM	PTFE/FKM	DIN 11851	448 481
									Clamp BS4825	554 147
	40	0... 1.80 [m³/h]	0... 45 [m³/h]	SS 304	2	SS 316L	PTFE/FKM	PTFE/FKM	DIN 11851	448 482
									Clamp ISO2852	448 501
									Clamp BS4825	554 147
	50	0... 2.88 [m³/h]	0... 72 [m³/h]	SS 304	2	SS 316L	PTFE/FKM	PTFE/FKM	DIN 11851	448 483
Clamp ISO2852									448 502	
Clamp BS4825									554 138	
65	0... 4.80 [m³/h]	0... 120 [m³/h]	SS 304	2	SS 316L	PTFE/FKM	PTFE/FKM	DIN 11851	448 484	
								Clamp ISO2852	448 503	
								Clamp BS4825	559 790	
80	0... 7.20 [m³/h]	0... 180 [m³/h]	SS 304	2	SS 316L	PTFE/FKM	PTFE/FKM	DIN 11851	448 485	
								Clamp ISO2852	448 504	
								Clamp BS4825	558 854	
100	0... 11.20 [m³/h]	0... 280 [m³/h]	SS 304	2	SS 316L	PTFE/FKM	PTFE/FKM	DIN 11851	448 486	
								Clamp ISO2852	448 505	
								Clamp BS4825	on request	

i Further versions on request

Please also use the "request for quotation" form on page 9 for ordering a customized sensor fitting [go to page](#).

Electronics Type SE56 (for more data, refer to data sheet Type SE56)

Description	Power supply	Outputs	Body material	Electrical connection	Item no.
Standard compact version with display	90... 265 V AC	2 transistors	Aluminium	6 cable glands	558 745
			Stainless steel	6 cable glands	559 780
		2 transistors + 4... 20 mA	Aluminium	6 cable glands	558 747
			Stainless steel	6 cable glands	558 306
Standard wall-mounting version with display	90... 265 V AC	2 transistors	Aluminium	6 cable glands	559 781
			Stainless steel	6 cable glands	558 310
		2 transistors + 4... 20 mA	Aluminium	6 cable glands	558 750
			Stainless steel	6 cable glands	558 308
Basic compact version with display	90... 265 V AC	2 transistors	Nylon	3 cable glands	562 439
		2 transistors + 4... 20 mA	Nylon	3 cable glands	562 440
	18... 63 V DC	2 transistors	Nylon	3 cable glands	562 443
		2 transistors + 4... 20 mA	Nylon	3 cable glands	562 444
Basic compact version without display	90... 265 V AC	2 transistors	Nylon	3 cable glands	562 441
		2 transistors + 4... 20 mA	Nylon	3 cable glands	562 442
	18... 63 V DC	2 transistors	Nylon	3 cable glands	562 445
		2 transistors + 4... 20 mA	Nylon	3 cable glands	562 446
Blind compact version	20... 30 V DC	up to 4 transistors	Stainless steel	2 cable glands	559 132
		up to 4 transistors + 4... 20 mA	Stainless steel	2 cable glands	559 133
		up to 4 transistors + PROFIBUS DP	Stainless steel	2 cable glands	559 134

Ordering chart for spare parts/accessories for sensor fitting Type S056

Description	Purpose	No. on drawing	Item no.
Electrode cable, 10 m long	for connection between sensor fitting Type S054/S055 without junction box, S051 or S056 and electronics Type SE56*	1	448 518
	for connection between sensor fitting Type S054/S055 with junction box and electronics Type SE56* or for connection between extension cable kit and electronics Type SE56*	4	562 851
Coil cable, 10 m long	for connection between sensor fitting Type S054/S055 without junction box S051 or S056 and electronics Type SE56*	2	448 519
	for connection between sensor fitting Type S054/S055 with junction box and electronics Type SE56* or for connection between extension cable kit and electronics Type SE56*	5	562 852
Extension cable kit	including a connecting box and resin	3	562 853

* (see corresponding data sheet)

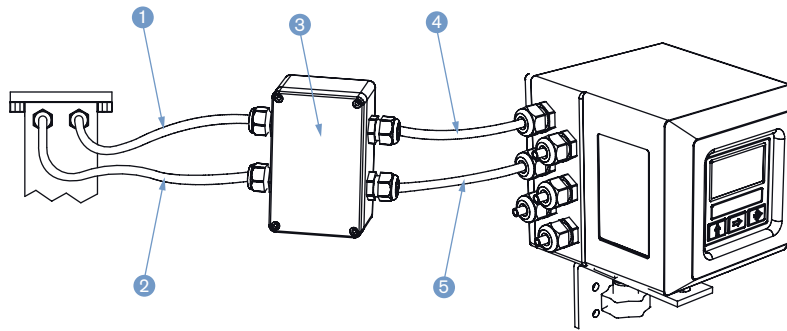

i Further versions on request

Electrical connection
Electrode and coil cables length

Sanitary sensor fitting Type S056 - request for quotation

Note

You can fill out the fields directly in the PDF file before printing out the form.

Please fill out and send to your nearest Bürkert facility* with your inquiry or order.

**NOTE:**

Please take into account that the sensor fitting Type S056 must be associated with one of the electronics Type SE56.

If only the sensor fitting is ordered, please indicate on your order the version (standard, blind or basic) or better the item no. of the electronics Type SE56 with which it will be associated

Company:	Contact person:
Customer No.:	Department:
Address:	Tel. / Fax.:
Postcode / Town:	E-mail:

Full Bore Magflow sensor fitting S056 sanitary versionQuantity: Desired delivery date: ■ **Pipe diameter:**

- DN03 DN06 DN10 DN15
 DN20 DN25 DN32 DN40
 DN50 DN65 DN80 DN100

■ **Process connection:**

- DIN11850 Clamp ISO2852 Clamp BS4825 SMS (on from DN10)

■ **Materials:**

Body in stainless steel 304 and 2 electrodes in stainless steel 316L

Seal FKM EPDM

■ **Flowmeter version:**

- Compact Remote (10 m cable included)

■ **Cable length:**

meter (for cable length > 20 m a preamplifier is included. Caution! Price increase)

Electronics SE56

When you click on the orange box "More info.", you will come to our website for the resp. product where you can download the data sheet, and then you can fill out the SE56 request for quotation form.