

## 2/2-way Angle-Seat Control Valve with stainless steel design for media up to +185°C, DN15-50



- Excellent combination of good control characteristic and high flow rates
- High cycle life
- Clean design for optimal use in hygienic environment

Type 2300 clamp can be combined with...



**Type 8692/8693**  
Positioner / Process Controller TopControl



**Type 8694**  
Positioner TopControl Basic



**Type 8696**  
Positioner TopControl Basic



**Type 8792/93**  
SideControl Remote version

In line with Bürkert's philosophy for modular valves and sensors the construction of the 2300 angle-seat valve fulfils tough criteria for process environments. Unrivalled cycle life and sealing integrity is guaranteed by the proven self adjusting spindle packing with V-seals.

The parabolic trim results in a flow characteristic approximately 35% larger than conventional control valves. It is available in either stainless steel on stainless steel or with a durable PTFE seal for tight shut-off.

The design enables the easy integration of automation modules whether they are digital electropneumatic positioner or process controller.

The fully integrated system has a compact and smooth design, integrated pneumatic lines, IP65/67 protection class and superior chemical resistance.

This system has been engineered for reliable accurate control in applications where high flow rate is an advantage.

Technical data	
<b>Orifice</b>	DN15 to 50
<b>Port connections</b>	ISO 2852, ASME BPE (DIN 32676, BS4825 on request)
Clamp acc. to Threaded port and welded - see separate datasheets	
<b>Body material</b>	Stainless steel 316L
<b>Actuator material</b>	PPS Stainless steel 1.4561 (316Ti)
Actuator Cover	
<b>Plug sealing</b>	PTFE/St.st. (PTFE/stainless steel) and St.st./St.st. (stainless steel/stainless steel)
<b>Seat leakage IEC 534-4/EN 1349</b>	Shut-off class III and IV for St.st./St.st. Shut-off class VI for PTFE/St.st.
<b>Medium</b>	Water, alcohol, oils, fuels, hydraulic fluids, salt solution, alkali solutions, organic solvents, steam
<b>Viscosity</b>	max. 600 mm <sup>2</sup> /s
<b>Spindle packing</b>	PTFE V-seals with spring compensation
<b>Medium temperature</b>	-10 to +185 °C (max. +130°C for PTFE/St.st. sealing)
<b>Ambient temperature</b>	0 to +55 °C (when used with positioner or process controllers) 0 to +80 °C (remote version)
<b>Control medium</b>	Compressed air
<b>Relevant pilot pressure for circuit function A</b>	5.5 to 7 bar
<b>Pilot air ports</b>	Push-in connector for external ø 6 mm or 1/4" tube
<b>Installation</b>	As required, preferably with actuator in upright position
<b>Surface Finish, standard on request</b>	in internal connection area, Ra<=0,6 (electro polished) outer cast surface

### Content



#### Valve specifications

##### Type 2300 clamp

Technical data & ordering info. p. 1-4



#### System Continuous ELEMENT

##### Type 8802-YG

Ordering info. & technical data p. 5-9

#### Request for quotation

##### Type 8802-YG

p. 10

Technical data Type 2300, continued

$K_{vs}$  values water/pressure

Orifice [mm]	Actuator size [mm]	$K_{vs}$ value water (m <sup>3</sup> /h)	Minimum pilot pressure [bar] *	Operating pressure up to +185°C NC [bar] *
15	50 / 70	5	5.5	16
20	50 / 70	10	5.5	10 / 16
25	50 / 70 / 90	16	5.5	5 / 12 / 16
32	70 / 90	23	5.5	6 / 16
40	90	34	5.5	12
	130	36	5.5	16
50	90	49	5.5	7
	130	53	5.5	16

\* For NO (normally open) see charts on page 4

**Flow rate:**  $K_{vs}$  value water [m<sup>3</sup>/h]: Measured at +20 °C, 1 bar pressure at valve inlet and free outlet.

**Pressure valves [bar]:** Overpressure to the atmospheric pressure

Flow characteristic

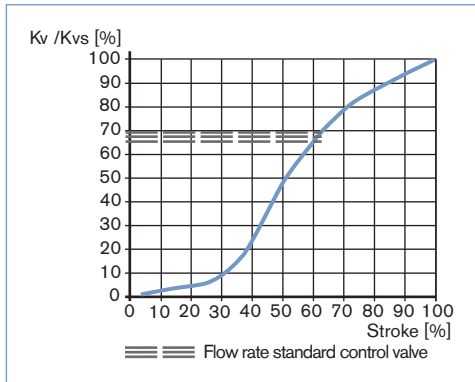

Remarks on the flow characteristic

Modified equi-percentile flow characteristic, engineered for a quick response during peak flow demand (an advantage for many processes like heating/cooling with heat exchangers) and fine control at lower flow.

$K_{vs}$  values [m<sup>3</sup>/h]

Orifice [mm]	Actuator size [mm]	Stroke [%]										
		5	10	20	30	40	50	60	70	80	90	100
15	50 / 70	0.16	0.17	0.22	0.4	1.2	2.7	3.5	4.0	4.5	4.8	5
20	50 / 70	0.26	0.27	0.4	1.1	4.0	5.9	7.2	8.3	9.1	9.6	10
25	50 / 70 / 90	0.34	0.36	0.62	1.5	5.2	8.9	11.5	13.0	14.2	15.4	16
32	70 / 90	0.43	0.52	0.82	1.4	4.0	9.3	13.8	16.4	19.2	21.3	23
40	90	0.47	0.62	1.1	2.6	10.0	17.0	21.5	25.3	28.8	31.6	34
	130	0.48	0.66	1.4	5.1	14.0	20.0	24.3	28.3	31.7	34.5	36
50	90	0.85	1.1	1.6	2.7	10.2	20.0	28.6	35.6	40.6	45.0	49
	130	0.87	1.2	1.8	4.0	15.2	26.0	35.0	40.3	45.0	48.0	53

## Ordering chart Type 2300, flow direction below the seat (for gases and liquids)

Clamp acc. to ISO 2852

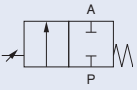
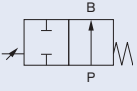
Control function	Orifice [mm]	Actuator size Ø [mm]	Port connection clamp external Ø [mm]	K <sub>vs</sub> value water [m³/h]	Operating pressure up to +185°C [bar]	Item no. plug sealing PTFE/St. st.	Leakage class	Item no. plug sealing St. st./St. st.	Leakage class
<b>A</b> 2/2-way valve, NC 	15	50	34.0	5	16	203 649	VI	223 423	IV
		70	34.0	5	16	203 650	VI	223 424	IV
	20	50	50.5	10	10	203 651	VI	223 425	III
		70	50.5	10	16	203 652	VI	223 426	IV
		90	50.5	16	12	203 654	VI	223 428	III
	25	50	50.5	16	5	203 653	VI	223 427	III
		70	50.5	16	16	245 401	VI	245 414	IV
		90	50.5	23	6	203 655	VI	223 429	III
	32	70	50.5	23	16	204 768	VI	245 415	IV
			90	50.5	23	16	203 656	VI	223 430
		130	64.0	36	16	223 304	VI	223 431	IV
			77.5	49	7	203 657	VI	223 433	III
	50	130	77.5	53	16	213 706	VI	223 434	IV
		<b>B</b> 2/2-way valve, NO 	15	50	34.0	5	see charts on page 4	203 658	VI
70	34.0			5	203 659	VI		223 436	IV
20	50		50.5	10	203 660	VI		223 437	III
	70		50.5	10	203 661	VI		223 438	IV
25	50		50.5	16	203 662	VI		223 439	III
	70		50.5	16	203 663	VI		223 440	III
32	70		50.5	23	203 664	VI		223 441	III
	90		64.0	34	203 665	VI		223 442	IV
50	90		77.5	49	203 666	VI		223 443	III

Clamp acc. to ASME BPE

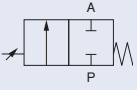
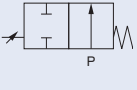
Control function	Orifice [mm]	Actuator size Ø [mm]	Port connection clamp external Ø [mm]	K <sub>vs</sub> value water [m³/h]	Operating pressure up to +185°C [bar]	Item no. plug sealing PTFE/St. st.	Leakage class	Item no. plug sealing St. st./St. st.	Leakage class	
<b>A</b> 2/2-way valve, NC 	15	50	25.0	5	16	203 667	VI	223 444	IV	
		70	25.0	5	16	203 668	VI	223 445	IV	
	20	50	25.0	10	10	203 669	VI	223 446	III	
		70	25.0	10	16	203 670	VI	223 447	IV	
	25	50	50.5	16	5	203 671	VI	223 448	III	
		70	50.5	16	12	203 672	VI	223 449	III	
		90	50.5	16	16	245 402	VI	245 416	IV	
	40	90	50.5	34	12	203 673	VI	223 450	III	
		130	50.5	36	16	223 305	VI	223 451	IV	
			77.5	49	7	203 674	VI	223 452	III	
	50	130	64.0	53	16	213 707	VI	223 453	IV	
		<b>B</b> 2/2-way valve, NO 	15	50	25.0	5	see charts on page 4	203 675	VI	223 454
	70			25.0	5	203 677		VI	223 455	IV
	20		50	25.0	10	203 678		VI	223 456	III
70			25.0	10	203 679	VI		223 457	IV	
25	50		50.5	16	203 680	VI		223 458	III	
	70		50.5	16	203 681	VI		223 459	III	
40	90		50.5	34	203 682	VI		223 460	IV	
	90		64.0	49	203 683	VI		223 461	III	

 Further versions on request

 Port connection  
Clamp acc. to DIN 32676, BS4825

 Control function  
B (spring-return normally-open) and I (double-acting)

Materials Type 2300

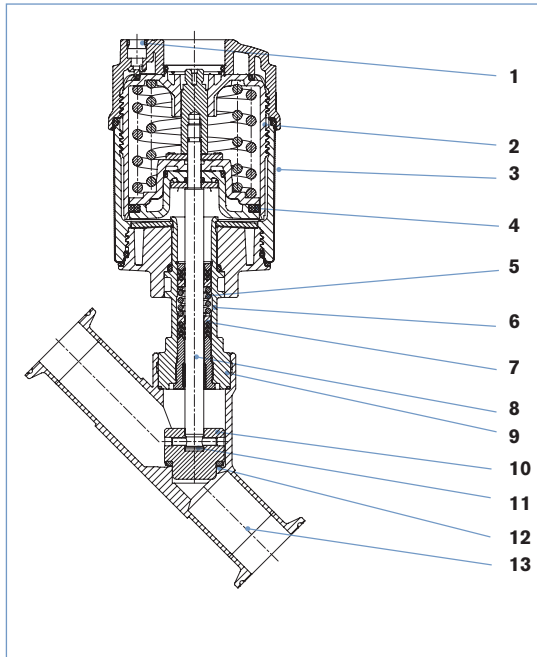

- |                               |  |
|-------------------------------|--|
| <b>1 Pilot air ports</b>      | Push-in connector PP (standard)                          |
| <b>2 Actuator</b>             | PPS  |
| <b>3 Cover</b>                | Stainless steel 1.4561 (316Ti)                           |
| <b>4 Piston seal</b>          | FKM  |
| <b>5 Spring</b>               | Stainless steel 1.4310                                   |
| <b>6 Tube</b>                 | Stainless steel 1.4401 (316) / 1.4404 (316L)             |
| <b>7 Spindle packing</b>      | PTFE   |
| <b>8 Spindle</b>              | Stainless steel 1.4401 (316) / 1.4404 (316L)             |
| <b>9 Spindle guidance</b>     | Stainless steel 1.4404 (316L)                            |
| <b>10 Plug</b>                | Stainless steel 1.4571                                   |
| <b>11 Spring straight pin</b> | Stainless steel 1.4310                                   |
| <b>12 Plug seal</b>           | Stainless steel 1.4571 / PTFE disc for soft seat sealing |
| <b>13 Valve body</b>          | Stainless steel 316L                                     |

Pressure Charts with control function B (normally open, NO)

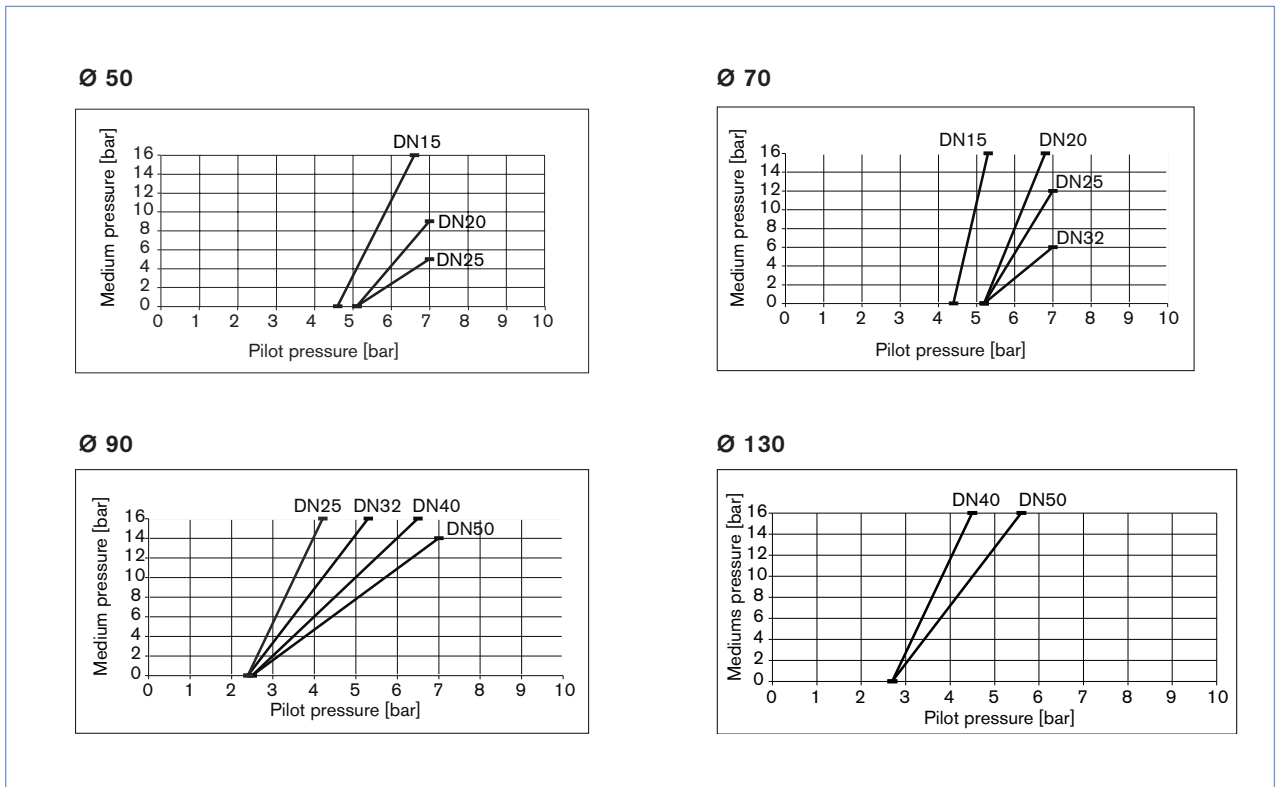







**Ordering information for valve system Continuous ELEMENT Type 8802-YG**

A valve system Continuous ELEMENT Type 8802-YG consists of an angle-seat control valve Type 2300 and a digital electropneumatic Positioner Type 8692, a digital electropneumatic Process Controller Type 8693, a digital electropneumatic Positioner Basic Type 8694 (below), an electropneumatic Positioner Type 8792/8793 (for valve actuator sizes  $\varnothing$  70/90/130 mm) or a digital electropneumatic Positioner Type 8696 (for valve actuator size  $\varnothing$  50 mm) (see next page and separate datasheets). For the configuration of further valve systems please use the "Request for quotation" on p. 11

[go to page](#)

You order two components and receive a complete assembled and certified valve.

**Ordering the valve system Continuous ELEMENT Type 8802-YG**

Angle seat valve Type 2300	Positioner		
			
	Positioner Type 8692	Process Controller Type 8693	Positioner Basic Type 8694
<b>Angle seat valve with desired control unit</b>			
	<b>Valve system Continuous ELEMENT Type 8802-YG-I 2300 + 8692</b>	<b>Valve system Continuous ELEMENT Type 8802-YG-J 2300 + 8693</b>	<b>Valve system Continuous ELEMENT Type 8802-YG-L 2300 + 8694</b>

When you click on the orange box "More info." below, you will come to our website for the resp. product where you can download the datasheet.

**Positioner TopControl Type 8692** [More info.](#)

**Process Controller TopControl Type 8693** [More info.](#)



**PROFIBUS** **DeviceNet™**

The new generation of integrated positioners/process controllers for combination with actuators from the process valve series Type 23xx/2103 is specially designed for the requirements of hygienic process environments. The easy handling and the selection of additional software functions are done either on a big graphic display with backlight and keypad or via a PC interface. A contact-free analogue position sensor registers the valve position without deterioration. Single-acting or double-acting actuators are controlled via the integral positioner system. With Type 8693, the process controller function is superimposed on the position control loop. Profibus DPV1 and DeviceNet communication interfaces are available as options.

Main customer benefits:

- Compact design of the valve system with integrated positioner/process controller meets the demands for plant washdown environments through the selection of materials, external seals and integrated control air supply to the actuator
- Extremely simple commissioning and operation thanks to the backlighting of the graphics display and proven multilingual software structure
- Automatic parameterisation of the positioner and process controller using the TUNE functions
- Field bus communication via Profibus DPV1 or DeviceNet
- Air intake filter enhances the process valve system availability
- Simple and reliable actuator adaption

**Positioner TopControl Basic Type 8694** [More info.](#)



The new generation of integrated positioners for combination with actuators from the process valve series Type 23xx/2103 is specially designed for the requirements of hygienic process environments. The operation and selection of the software functions close tight function, inversion of the operating direction of the setpoint signal, characteristic curves selection and switching manual/automatic operation are effected via push-buttons and DIP switches or via the PC interface. The position setpoint is set using the standard signal 4 - 20 mA. In addition, the enable can be controlled via the binary input and an optional position feedback can be integrated. The positioner, Type 8694, registers the valve position without deterioration through a contact-free analogue position sensor. Single-acting or double-acting actuators are controlled via the integral positioner system. An AS-Interface communication interface is available as an option.

Main customer benefits:

- Compact design of the valve system with integrated positioner meets the demands for plant washdown environments through the selection of materials, external seals and integrated control air supply to the actuator
- Automatic parameterisation of the positioner using the Process TUNE function
- Field bus communication via optional AS-Interface
- Air intake filter enhances the process valve system availability
- Simple and reliable actuator adaption allowing additional actuators of the process valve series, Type 20xx or actuators from other manufacturers to be used

**Ordering information for valve system Continuous ELEMENT Type 8802-YG, continued**

A valve system Continuous ELEMENT Type 8802-YG consists of an angle-seat control valve Type 2300 and a digital electropneumatic Positioner Type 8692, a digital electropneumatic Process Controller Type 8693, a digital electropneumatic Positioner Basic Type 8694 (previous page), an electropneumatic Positioner Type 8792/8793 (for valve actuator sizes  $\varnothing$  70/90/130) mm or a digital electropneumatic Positioner Type 8696 (for valve actuator size  $\varnothing$  50 mm) (see separate datasheets). For the configuration of further valve systems please use the "Request for quotation" on p. 11 [go to page](#)

You order two components and receive a complete assembled and certified valve.

**Ordering the valve system Continuous ELEMENT Type 8802-YG**

**Angle seat valve Type 2300**



**Positioner**



Positioner  
Type 8792/  
Process Controller Type 8793



TopControl Basic Type 8696  
Only for actuator size  
 $\varnothing$  50 mm

**Angle seat valve  
with desired control unit**



Valve system  
Continuous ELEMENT  
Type 8802-YG-P  
2300 + 8792 /  
Type 8802-YG-Q  
2300 + 8793



Valve system  
Continuous ELEMENT  
Type 8802-YG-N  
2300 + 8696

When you click on the orange box "More info." below, you will come to our website for the resp. product where you can download the datasheet.

**Positioner SideControl Type 8792**

**More info.**

**Process Controller SideControl Type 8793**

**More info.**



Type 8792/8793 is a digital electro-pneumatic positioner with an optional, integrated process controller (8793) for precise control requirements. The compact design with integrated position encoder and LCD display was developed for demanding applications of the process industry. A Profibus DPV1 communication interface is available as an option.

Main customer benefits are:

- Time saving algorithms for temperature, flow and pressure PID parameters through ProcessTUNE function.
- Quick and simple menu driven parameterization through keyboard or Profibus DPV1 PA
- Adaption acc. to IEC534-6 and VDI/VDE 3845 for lift and swivel drives or as a Remote version together with Bürkert process valves
- Rugged anodised aluminium housing

**TopControl Basic Type 8696**

**Mehr Infos**



The new generation of integrated positioners for combination with small actuators from the process valve series Type 23xx/2103 is specially designed for the requirements of hygienic process environments. The operation and selection of the software functions close tight function, inversion of the operating direction of the setpoint signal, characteristic curves selection and switching manual/automatic operation are effected via push-buttons and DIP switches or via the PC interface. The position setpoint is set using the standard signal 4 - 20 mA. In addition, the enable can be controlled via the binary input and an optional position feedback can be integrated. The positioner, Type 8696, registers the valve end position without deterioration through a contact-free analogue position sensor. Single-acting actuators are controlled via the integral positioner system.

Main customer benefits:

- Compact design of the valve system with integrated positioner meets the demands for plant washdown environments through the selection of materials, external seals and integrated control air supply to the actuator
- Automatic parameterisation of the positioner using the TUNE function
- Simple and reliable actuator adaption

Dimensions for valve system Continuous ELEMENT Type 8802-YG [mm]

Dimensions valve system Continuous ELEMENT Type 8802-YG-I with positioner TopControl Type 8692 or 8802-YG-J with process controller TopControl Type 8693 [mm]

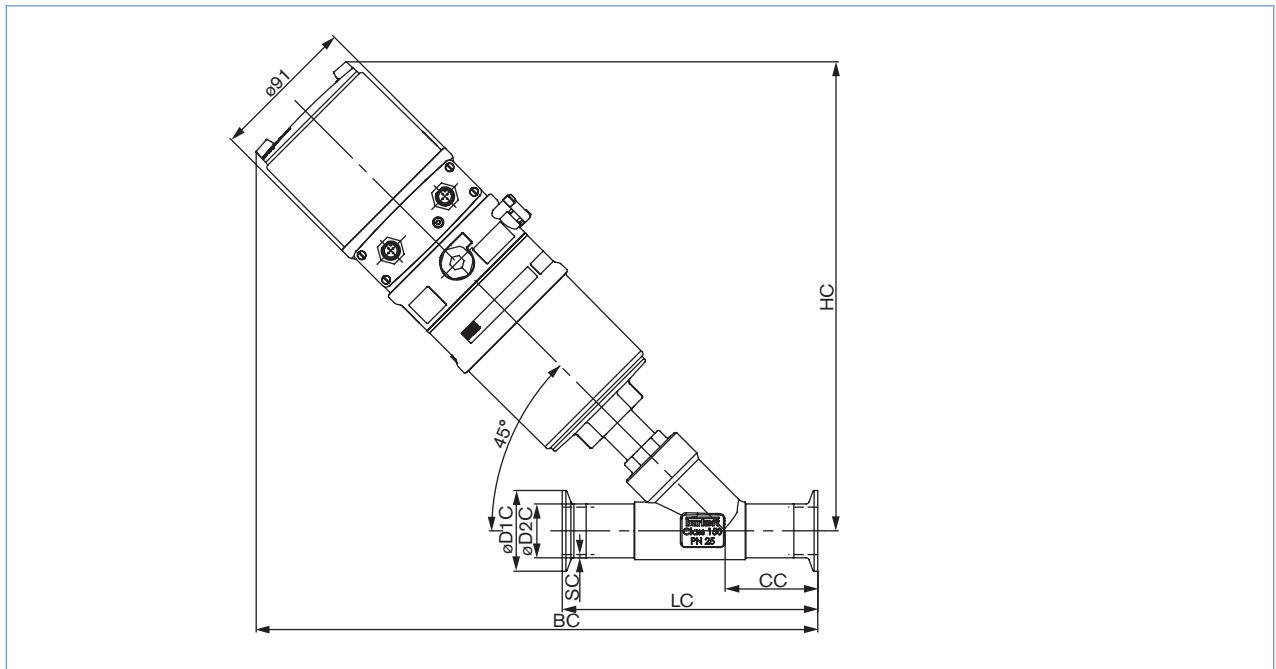

Ori- fice [mm]	Actuator size [mm]				ISO 2852				DIN 32676				BS 4825				ASME BPE			
		HC	BC	LC	CC	øD1C	øD2C	SC	CC	øD1C	øD2C	SC	CC	øD1C	øD2C	SC	CC	øD1C	øD2C	SC
15	70	285	338	130	49	34	21.3	1.6	49.5	34	19	1.5	49	25.2	12.7	1.2	49	25	12.7	1.65
20	70	293	353	150	56.5	50.5	26.9	1.6	57	34	23	1.5	56.5	25.2	19.05	1.2	56.5	25	19.05	1.65
25	70	295	356	160	58	50.5	33.7	2	58.5	50.5	29	1.5	58	50.5	25.4	1.65	58	50.5	25.4	1.65
	90	332	391	160	58	50.5	33.7	2	58.5	50.5	29	1.5	58	50.5	25.4	1.65	58	50.5	25.4	1.65
32	70	304	365	180	57.5	50.5	42.4	2	58	50.5	35	1.5	-	-	-	-	-	-	-	-
	90	347	405	180	57.5	50.5	42.4	2	58	50.5	35	1.5	-	-	-	-	-	-	-	-
40	90	350	421	200	69	64	48.3	2	69.5	50.5	41	1.5	69	50.5	38.1	1.65	69	50.5	38.1	1.65
	130	387	456	200	69	64	48.3	2	69.5	50.5	41	1.5	69	50.5	38.1	1.65	69	50.5	38.1	1.65
50	90	366	445	230	77.5	77.5	60.3	2.6	78	64	53	1.5	77.5	64	50.8	1.65	77.5	64	50.8	1.65
	130	403	480	230	77.5	77.5	60.3	2.6	78	64	53	1.5	77.5	64	50.8	1.65	77.5	64	50.8	1.65

Dimensions for valve system Continuous ELEMENT Type 8802-YG [mm], continued

Dimensions valve system Continuous ELEMENT Type 8802-YG-L with positioner TopControl Basic Type 8694 [mm]

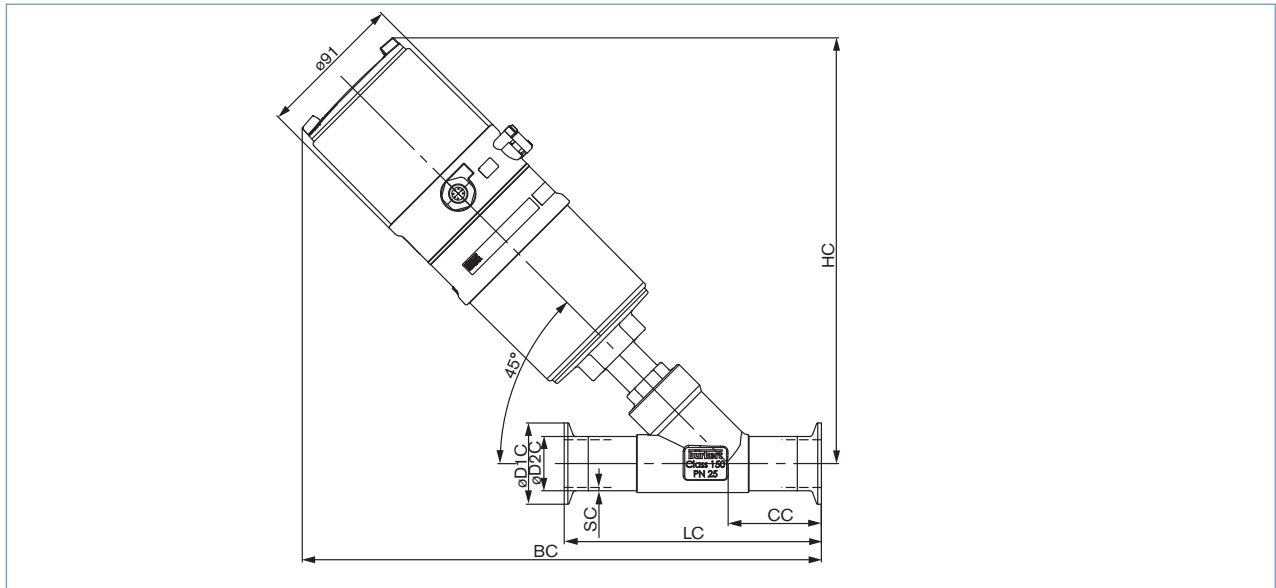

Orifice [mm]	Actuator size [mm]				ISO 2852				DIN 32676				BS 4825				ASME BPE			
		HC	BC	LC	CC	ø D1C	ø D2C	SC	CC	ø D1C	ø D2C	SC	CC	ø D1C	ø D2C	SC	CC	øD1C	øD2C	SC
15	70	256	309	130	49	34	21.3	1.6	49.5	34	19	1.5	49	25.2	12.7	1.2	49	25	12.7	1.65
20	70	264	324	150	56.5	50.5	26.9	1.6	57	34	23	1.5	56.5	25.2	19.05	1.2	56.5	25	19.05	1.65
25	70	266	327	160	58	50.5	33.7	2	58.5	50.5	29	1.5	58	50.5	25.4	1.65	58	50.5	25.4	1.65
	90	303	362	160	58	50.5	33.7	2	58.5	50.5	29	1.5	58	50.5	25.4	1.65	58	50.5	25.4	1.65
32	70	275	336	180	57.5	50.5	42.4	2	58	50.5	35	1.5	-	-	-	-	-	-	-	-
	90	318	376	180	57.5	50.5	42.4	2	58	50.5	35	1.5	-	-	-	-	-	-	-	-
40	90	321	392	200	69	64	48.3	2	69.5	50.5	41	1.5	69	50.5	38.1	1.65	69	50.5	38.1	1.65
	130	358	427	200	69	64	48.3	2	69.5	50.5	41	1.5	69	50.5	38.1	1.65	69	50.5	38.1	1.65
50	90	337	416	230	77.5	77.5	60.3	2.6	78	64	53	1.5	77.5	64	50.8	1.65	77.5	64	50.8	1.65
	130	374	451	230	77.5	77.5	60.3	2.6	78	64	53	1.5	77.5	64	50.8	1.65	77.5	64	50.8	1.65

Dimensions valve system Continuous ELEMENT Type 8802-YG-N with positioner TopControl Basic Type 8696 [mm]

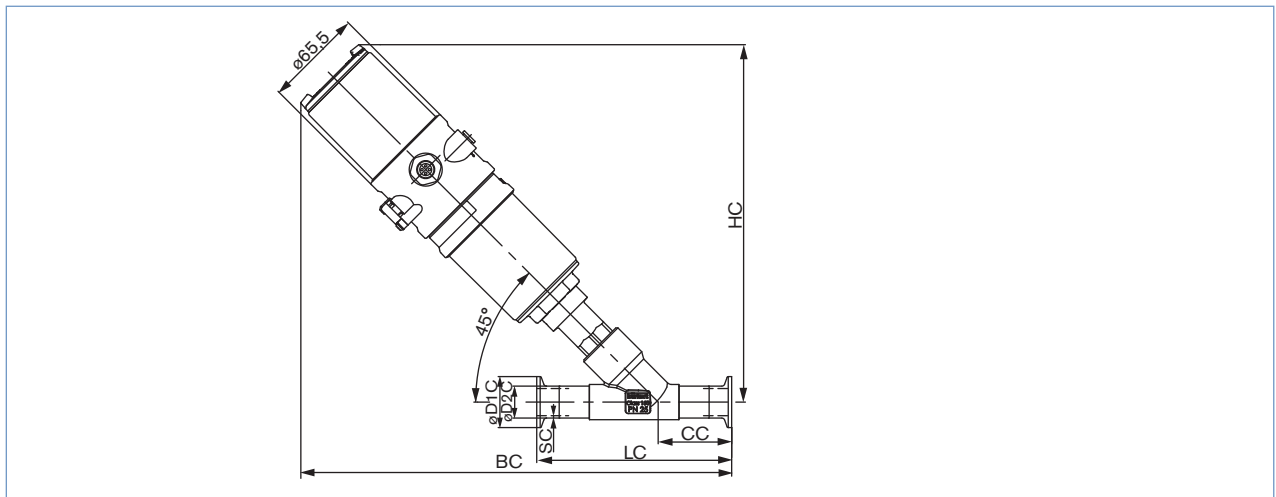

Orifice [mm]	Actuator size [mm]				ISO 2852				DIN 32676				BS 4825				ASME BPE			
		HC	BC	LC	CC	øD1C	øD2C	SC	CC	øD1C	øD2C	SC	CC	øD1C	øD2C	SC	CC	øD1C	øD2C	SC
15	50	239	291	130	49	34	21.3	1.6	49.5	34	19	1.5	49	25.2	12.7	1.2	49	25	12.7	1.65
20	50	247	306	150	56.5	50.5	26.9	1.6	57	34	23	1.5	56.5	25.2	19.05	1.2	56.5	25	19.05	1.65
25	50	248	309	160	58	50.5	33.7	2	58.5	50.5	29	1.5	58	50.5	25.4	1.65	-	-	-	-



Dimensions for valve system Continuous ELEMENT Type 8802-YG [mm], continued

Dimensions valve system Continuous ELEMENT Type 8802-YG-P with positioner SideControl Remote Type 8792 and Type 8802-YG-Q with Process Controller SideControl Remote Type 8793 [mm]

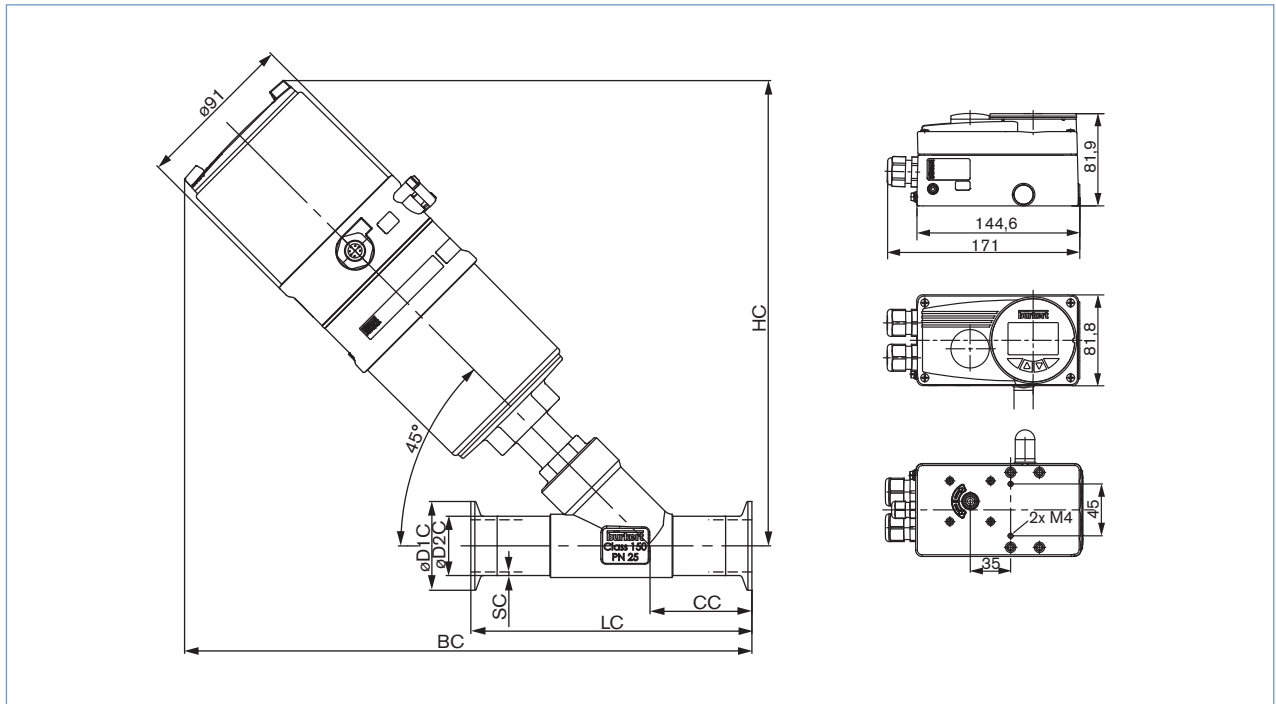

Orifice [mm]	Actuator size [mm]	ISO 2852				DIN 32676				BS 4825				ASME BPE						
		HC	BC	LC	CC	ø D1C	ø D2C	SC	CC	ø D1C	ø D2C	SC	CC	ø D1C	ø D2C	SC				
15	70	256	309	130	49	34	21.3	1.6	49.5	34	19	1.5	49	25.2	12.7	1.2	49	25	12.7	1.65
20	70	264	324	150	56.5	50.5	26.9	1.6	57	34	23	1.5	56.5	25.2	19.05	1.2	56.5	25	19.05	1.65
25	70	266	327	160	58	50.5	33.7	2	58.5	50.5	29	1.5	58	50.5	25.4	1.65	58	50.5	25.4	1.65
	90	303	362	160	58	50.5	33.7	2	58.5	50.5	29	1.5	58	50.5	25.4	1.65	58	50.5	25.4	1.65
32	70	275	336	180	57.5	50.5	42.4	2	58	50.5	35	1.5	-	-	-	-	-	-	-	-
	90	318	376	180	57.5	50.5	42.4	2	58	50.5	35	1.5	-	-	-	-	-	-	-	-
40	90	321	392	200	69	64	48.3	2	69.5	50.5	41	1.5	69	50.5	38.1	1.65	69	50.5	38.1	1.65
	130	358	427	200	69	64	48.3	2	69.5	50.5	41	1.5	69	50.5	38.1	1.65	69	50.5	38.1	1.65
50	90	337	416	230	77.5	77.5	60.3	2.6	78	64	53	1.5	77.5	64	50.8	1.65	77.5	64	50.8	1.65
	130	374	451	230	77.5	77.5	60.3	2.6	78	64	53	1.5	77.5	64	50.8	1.65	77.5	64	50.8	1.65

**Note**

You can fill out the fields directly in the PDF file before printing out the form.

**Valve system Continuous ELEMENT Type 8802-YG - Request for quotation**

▶ Please fill out and send to your nearest Bürkert facility\* with your inquiry or order

Company	Contact person
Customer no.	Department
Address	Tel./Fax
Postcode/town	E-mail

= mandatory fields to fill out

Quantity

Required delivery date

**Operating data**

Pipe line	DN	<input type="text"/>	PN	<input type="text"/>
Pipe material	<input type="text"/>			
Process medium	<input type="text"/>			
Type of medium	<input type="checkbox"/> Liquid	<input type="checkbox"/> Steam	<input type="checkbox"/> Gas	
Flow rate (Q, Q <sub>N</sub> , W) <sup>1)</sup>	min	standard	max	unit
Temperature at valve inlet T1	<input type="text"/>	<input type="text"/>	<input type="text"/>	<input type="text"/>
Absolute pressure at valve inlet P1	<input type="text"/>	<input type="text"/>	<input type="text"/>	<input type="text"/>
Absolute pressure at valve outlet P2	<input type="text"/>	<input type="text"/>	<input type="text"/>	<input type="text"/>
Steam pressure P <sub>v</sub>	<input type="text"/>	<input type="text"/>	<input type="text"/>	<input type="text"/>
Kinematic viscosity (ν)	<input type="text"/>	mm <sup>2</sup> /s or cSt		
Dynamic viscosity (η)	<input type="text"/>	mPa.s or cP		
Standard density	<input type="text"/>	Kg/m <sup>3</sup>		
Max. sound level accepted	<input type="text"/>	dB (A)		

<sup>1)</sup> standard unit: Liquid Q = m<sup>3</sup>/h; Steam W = kg/h; Gas Q<sub>N</sub> = Nm<sup>3</sup>/h







**Valve features**

Plug seal material	<input type="checkbox"/> PTFE/Stainless steel	<input type="checkbox"/> Stainless steel/Stainless steel	
Nominal pressure	PN	<input type="text"/>	
Orifice	DN	<input type="text"/>	
Type of connection	<input type="checkbox"/> Threaded	<input type="checkbox"/> Welded	<input type="checkbox"/> Clamp
Standard connection	<input type="checkbox"/> ISO	<input type="checkbox"/> DIN	<input type="checkbox"/> Other <input type="text"/>
Control function	<input type="checkbox"/> NC <sup>2)</sup>	<input type="checkbox"/> NO <sup>2)</sup>	
Please specify item no. if known:	<input type="text"/>		

<sup>2)</sup> NC: normally closed by spring action; NO: normally open by spring action

**Comments**

Valve system Continuous ELEMENT Type 8802-YG - Request for quotation, continued

Control unit features		
For actuator sizes 70/90/130 mm		
<input type="checkbox"/> Positioner TopControl Type 8692  <input type="checkbox"/> Process Controller TopControl Type 8693 	<input type="checkbox"/> Positioner TopControl Basic Type 8694 	<input type="checkbox"/> Positioner SideControl Remote Type 8792  <input type="checkbox"/> Process Controller SideControl Remote Type 8793 
<p><b>Pneumatic function</b></p> <input type="checkbox"/> Single-acting <input type="checkbox"/> Double-acting <p><b>Communication</b></p> <input type="checkbox"/> Profibus <input type="checkbox"/> DeviceNet <p><b>Electrical connection</b></p> <input type="checkbox"/> Cable gland <input type="checkbox"/> Multipol connection <p><b>Feedback</b></p> <input type="checkbox"/> 4-20 mA <input type="checkbox"/> 4-20 mA + 2 binary outputs <p><b>Initiator</b></p> <input type="checkbox"/> Initiator <p>Please specify item no. if known: <input type="text"/></p>	<p><b>Pneumatic function</b></p> <input type="checkbox"/> Single-acting <p><b>Pilot air ports</b></p> <input type="checkbox"/> Push-in connector external ø 6 mm or 1/4" <input type="checkbox"/> Thread G 1/8" <p><b>Electrical connection</b></p> <input type="checkbox"/> Cable gland <input type="checkbox"/> Multipol connection <p><b>Feedback</b></p> <input type="checkbox"/> 4-20 mA <p>Please specify item no. if known: <input type="text"/></p>	<p><b>Power supply</b> 24 VDC</p> <p><b>Communication</b></p> <input type="checkbox"/> Without <input type="checkbox"/> Profibus DPV1 <p><b>Feedback</b></p> <input type="checkbox"/> Analogue feedback + 2 binary outputs <input type="checkbox"/> 2 binary outputs <p><b>Electrical connection</b></p> <input type="checkbox"/> Cable gland <input type="checkbox"/> Multipol connection <p>Please specify item no. if known: <input type="text"/></p>
For actuator size 50 mm		
<input type="checkbox"/> Positioner TopControl Basic Typ 8696 		
<p><b>Pneumatic function</b></p> <input type="checkbox"/> Single-acting <p><b>Pilot air ports</b></p> <input type="checkbox"/> Push-in connector external ø 6 mm or 1/4" <input type="checkbox"/> Thread G 1/8" <p><b>Feedback</b></p> <input type="checkbox"/> 4-20 mA <p>Please specify item no. if known: <input type="text"/></p>		