



2/2-way Angle-Seat Valve for medium up to +180°C, threaded port connection, DN 15-65

- High flow rate
- Long life cycle
- NC and NO universal actuators with modular universal accessory program up to control heads
- Deliverable with flow direction below or above seat
- Simple conversion of the control function

Type 2000 can be combined with...



Typ 8691

Control head



Typ 8690

Pneum. control unit with feedback



Typ 1062

Electrical position feedback

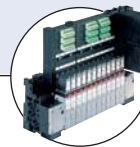

Typ 8640/8644

Valve block



Typ 6012/6014 P

Pilot valve

The externally piloted angle-seat valve is operated with a single or double-acting piston actuator. The actuator is available in two different materials, PA and PPS depending on the ambient temperature. The reliable self-adjusting packing gland provides high sealing integrity. High flow rates are attained with the gunmetal or cast stainless steel 2-way body. These maintenance-free and robust valves can be retrofitted with a comprehensive range of accessories for position indication, stroke limitation or manual override.

For valves with port connection clamp and weld end please see separate datasheets.

¹⁾ **Note:** For PA actuators in the sizes 40, 50 and 63, the combination of max. medium temperature and max. ambient temperature is as shown in the following chart

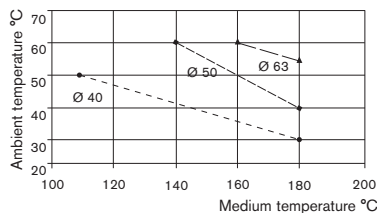

Technical data	
Orifice	DN 15 to 65
Body materials	Gunmetal, cast stainless steel 316L
Actuator material	PA or PPS
Seal material	PTFE (NBR, FKM, EPDM on request)
Medium	Water, alcohol, oils, fuel, hydraulic fluids, salt solution, alkali solutions, organic solvents, steam
Viscosity	max. 600 mm ² /s
Packing gland (with silicone grease)	PTFE V-rings with spring compensation
Medium temperature¹⁾	-10 to +180 °C with PTFE seal
Ambient temperature	
PA actuator ¹⁾	-10 to +60 °C
PPS actuator ¹⁾ Ø 40-80	+5 to +140 °C
PPS actuator ¹⁾ Ø 100-125	+5 to +90 °C, briefly up to +140 °C
Installation	As required, preferably with actuator in upright position
Control medium	Neutral gases, air
Max. pilot pressure	
Actuator size Ø 40-80	PA and PPS 10 bar
Actuator size Ø 100	PA 10 bar
Actuator size Ø 100	PPS 7 bar
Actuator size Ø 125	PA and PPS 7 bar
Port connection	G 3/8 to G 2 1/2 (NPT on request)

Content



Valve specifications

Type 2000 threaded port

Technical data & ordering info.

p. 1-7



System spec. On/Off Classic

**Type 8801-YA/
8803-YA**

Ordering info. & technical data

p. 8-11

Request for quotation

**Type 8801-YA/
8803-YA**

p. 12

Materials Type 2000 threaded port

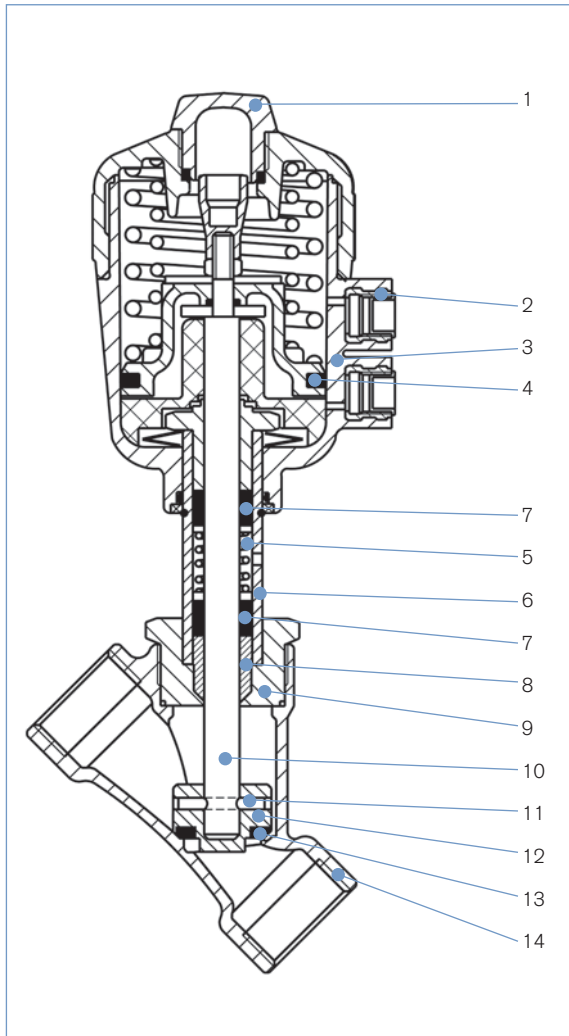

	Gunmetal body	Cast stainless steel body
1 Transparent cap	PC (with PPS actuator; PSU)	PC (with PPS actuator; PSU)
2 Pilot air ports	Brass	Stainless steel 1.4305
3 Actuator	PA, PPS	PA, PPS
4 Piston seal	NBR (with PPS actuator; FKM)	NBR (with PPS actuator; FKM)
5 Spring	Stainless steel 1.4310	Stainless steel 1.4310
6 Tube	Brass CuZn39Pb3	Stainless steel 1.4401
7 V-Seals	PTFE (FKM on request)	PTFE (FKM on request)
8 Wiper	PTFE	PTFE
9 Nipple	Brass CuZn	Stainless steel 1.4401
10 Spindle	Stainless steel 1.4021	Stainless steel 1.4401
11 Pin	Stainless steel 1.4401	Stainless steel 1.4401
12 Swivel plate	Brass CuZn36Pb1.5	Stainless steel 1.4401
13 Seal	PTFE (NBR, FKM, EPDM on request)	PTFE (NBR, FKM, EPDM on request)
14 Valve body	Gunmetal GCuSn5ZnPb2%Ni	Stainless steel 316L

Technical data Type 2000 threaded port, flow direction below seat (for gases and liquid)

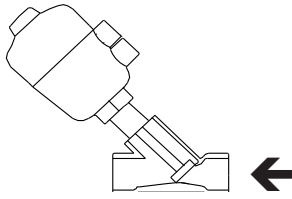

Flow direction below seat

Orifice [mm]	Actuator size [mm]	Kv value water (m ³ /h)	Min. pilot pressure CFA [bar]	Max. operating pressure up to ±180°		Weight [kg]
				CFA [bar]	CFB [bar]	
15	40	3.7	4.0	15	16	0.8
	50	4.2	3.9	16	16	0.8
20	40	7.0	4.0	6.5	16	0.9
	50	8.5	3.9	11	16	1.0
	63	9.0	4.5	16	–	1.4
25	50	10	–	–	16	1.2
	63	18	4.5	11	16	1.8
	80	18	5.0	16	16	2.2
32	63	25	4.5	6	16	2.2
	80	27	5.0	14	16	3.1
40	63	35	–	–	16	2.7
	80	38	5.0	9	16	3.5
	100	40	4.4	12.5	–	7.6
	125	40	3.2	16	–	9.0
50	63	49	–	–	13	4.0
	80	52	–	–	15	4.8
	100	55	4.4	7.2	–	7.0
	125	55	3.2	10	–	9.4
65	80	77	–	–	15	6.4
	125	90	3.2	5.2	–	11.0

Kv value water [m³/h]: Measured at +20 °C, 1 bar pressure at valve inlet and free outlet
 Pressure values [bar]: Measured as overpressure to the atmospheric pressure

Pilot pressure diagram with control function B and flow direction below seat

Diagram 1

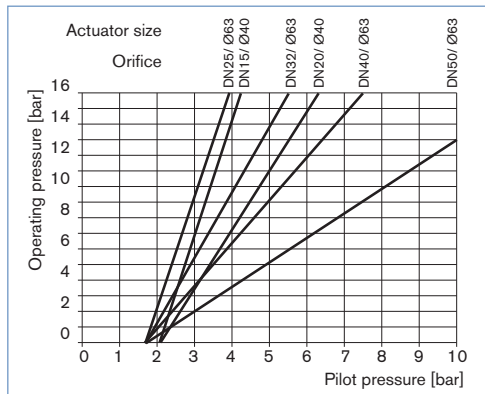
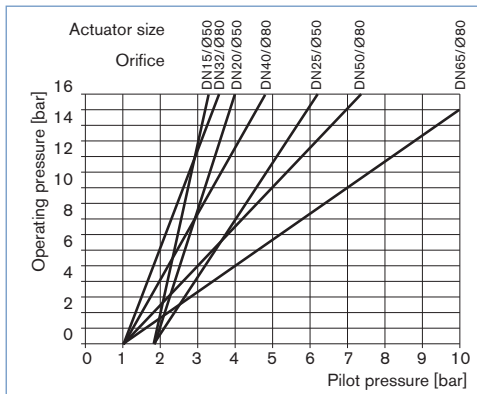
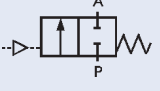
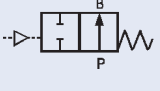

Diagram 2



Ordering chart Type 2000 threaded port, flow direction below the seat (for gases and liquid)

Different actuator and body materials

Control function	Port connection	Orifice [mm]	Actuator size Ø [mm]	Kv value water [m³/h]	Minimum pilot pressure [bar]	Max. operating pressure up to 180 °C [bar]	Gunmetal body		Cast st. st. body		
							Item no. PA actuator	Item no. PPS actuator	Item no. PA actuator	Item no. PPS actuator	
A 2/2-way, normally closed (NC) 	G 3/8	15	40	3.7	4.0	15	178 614	178 613	142 613	178 612	
	G 1/2		40	3.8	4.0	15	178 608	178 607	178 606	178 605	
			50	4.2	3.9	16	178 684	178 683	178 682	178 681	
	G 3/4	20	50	8.5	3.9	11	178 680	178 679	178 678	178 677	
			63	9.0	4.5	16	178 666	178 665	178 664	178 663	
	G 1		63	18	4.5	11	178 676	178 675	178 674	178 667	
			80	18	5.0	16	186 489	187 565	186 488	187 844	
	G 1 1/4	32	80	27	5.0	14	178 699	178 698	178 697	178 696	
	G 1 1/2		80	38	5.0	9	178 695	178 694	178 693	178 692	
			125	40	3.2	16	186 487	–	187 840	–	
	G 2	50	100	55.0	4.4	7.2	001 134	002 170	001 140	001 239	
			125	55.0	3.2	10	001 593	002 171	001 601	–	
	G 2 1/2		125	90.0	3.2	5.2	001 368	002 172	001 373	001 703	
	B 2/2-way, normally open (NO) 	G 3/8	15	40	3.7	see diagram 1 and 2 on previous page	16	140 368	178 610	142 616	178 609
G 1/2		40		3.8	16		178 601	178 602	178 603	178 604	
		50		4.2	16		178 691	178 690	178 689	178 688	
G 3/4		20	50	8.5	16		178 687	179 020	178 686	178 685	
G 1			50	10	16		178 850	178 849	178 848	178 847	
G 1 1/4			32	63	25		16	178 845	178 853	178 852	178 851
G 1 1/2		40	63	35	16		178 864	178 863	178 862	178 861	
G 2			50	63	49.0		13	001 371	002 179	001 376	001 709
			80	52	16		001 595	002 180	001 603	002 164	
G 2 1/2		65	80	77.0	15		001 372	002 181	001 377	001 710	

 Further versions on request
**Material**

Seal: NBR, FKM, EPDM

**Control function**

Double-acting actuator

**Port connections**

Clamp, weld end (see separate datasheets)

**Approvals**

GL, SIL

**Mediums temperature**

Valves for mediums temperature up to +200°C or down to -40°C

Technical data Type 2000 threaded port, flow direction above seat (only for gas and steam)

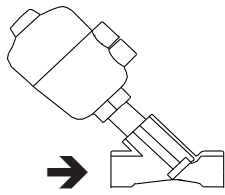

Flow direction above seat

Attention!

Valves with flow direction above the seat are only conditionally usable for liquid medium. There is a danger of waterhammer!

Orifice [mm]	Actuator size [mm]	Kv value water (m ³ /h)	Max. operating pressure up to 180° C	Weight [kg]
15	40	3.7	16	0.8
	50	4.2	16	0.8
20	40	7.9	16	0.9
	50	8.0	16	1.0
25	50	14.5	16	1.2
	63	19.0	16	1.8
32	63	27.0	16	2.2
40	63	35.0	16	2.7
	80	38.0	16	3.5
50	63	49.0	16	4.0
	80	52.0	16	4.8
65	80	77.0	14	6.4
	100	90.0	15	8.6

Kv value water [m³/h]: Measured at +20 °C, 1 bar pressure at valve inlet and free outlet
 Pressure values [bar]: Measured as overpressure to the atmospheric pressure

Technical data	Flow direction above seat (only for gases and steam)
Medium	Gaseous medium and steam
Further technical data	Please see information Technical data on page 1

Pilot pressure diagram with control function A and flow direction above seat

Diagram 3

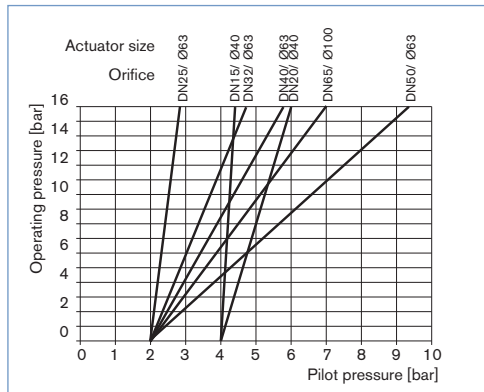
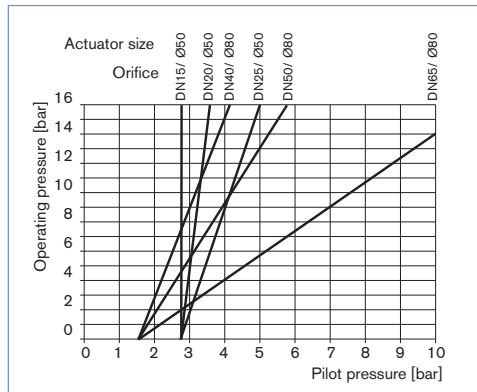

Diagram 4



Ordering chart Type 2000 threaded port, flow direction above the seat (only for gas and steam)

Various actuator and body materials

Minimum pilot pressure depending on operating pressure, please see diagram 3 and 4 on previous page

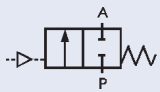
Control function	Port connection	Orifice [mm]	Actuator size Ø [mm]	Kv value water [m ³ /h]	Max. operating pressure to 180°C [bar]	Gunmetal body		Stainless steel body	
						Item no. PA actuator	Item no. PPS actuator	Item no. PA actuator	Item no. PPS actuator
A 2/2-way, normally closed (NC) 	G 3/8	15	40	3.7	16	186 588	■	142 615	■
	G 1/2		50	4.2	16	183 939	186 106	186 376	186 467
	G 3/4	20	40	7.9	16	186 822	■	187 672	■
			50	8.0	16	185 356	180 374	185 304	180 375
	G 1	25	50	14.5	16	186 380	187 556	186 729	187 872
			63	18.0	16	178 860	178 859	178 857	178 856
	G 1 1/4	32	63	25.0	16	178 855	178 854	178 893	178 892
	G 1 1/2	40	63	35.0	16	178 896	178 897	178 895	178 894
	G 2	50	63	49.0	16	001 251	002 149	001 401	002 158
	G 2 1/2	65	80	77.0	14	001 398	002 151	001 402	002 160
100			90.0	15	130 332	186 344	130 333	–	

■ on request

i Further versions on request



Material
Seal: NBR, FKM, EPDM



Control function
Double-acting actuator



Port connections
Clamp, weld end (see separate datasheets)



Approvals
GL, SIL



Mediums temperature
Valves for mediums temperature up to +200°C or down to -40°C

Ordering chart for accessories

3/2-way pilot valves with banjo bolts

Seal material valve FKM, seal material banjo bolt NBR

Valve for actuator size [Ø mm]	Type	Pressure inlet P (valve body)	Service port A (banjo bolt)	Orifice [mm]	Qn value air [l/min]	Pressure range [bar]	Electrical coil connection Ind. Std.	Power consumption [W]	Item no. Voltage/frequency [V/Hz]
									024/DC 230/50
50-63	6012P	Tube fitting ø6 mm	G 1/4	1.2	48	0-10	Form B	4	552 283 552 286
40	6012P	G 1/4	G 1/8	1.2	48	0-10	Form B	4	552 295 552 298
50-125	6014P	G 1/4	G 1/4	2	120	0-10	Form A	8	424 103 424 107

Cable plug Type 2507, Form B or Type 2508, Form A

	Item no.
Type 2507, Form B Industrial standard, 0 to 250 V without circuitry (Type 6012 P)	423 845
Type 2508, Form A acc. DIN EN 175301-803, 0 to 250 V without circuitry (Type 6014 P, Type 0331P)	008 376

For further accessories see datasheet for Type 1062 or the accessories datasheet Type 2XXX for the full options programme.

Note: For design reasons, some of the accessories cannot be supplied for actuator size Ø 40 mm. Please request the accessories datasheet Type 2XXX.

Dimensions Type 2000 threaded port [mm]

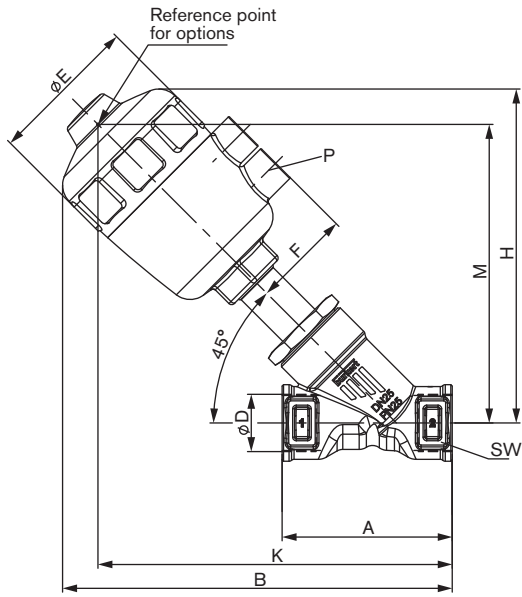

Orifice	Actuator size \varnothing	Port connection D	A	B	$\varnothing E$	H	K	M	P	SW
15	40	G 3/8	65	139	53	115	125	100	G 1/8	27
		G 1/2		139	53	115	125	100	G 1/8	
	50	G 3/8		163	64	140	147	123	G 1/4	
		G 1/2		163	64	140	147	123	G 1/4	
20	40	G 3/4	75	147	53	120	133	106	G 1/8	34
	50			171	64	144	155	129	G 1/4	
	63			198	80	171	179	152	G 1/4	
25	50	G 1	90	181	64	152	166	136	G 1/4	41
	63			206	80	177	188	158	G 1/4	
	80			228	101	198	204	173	G 1/4	
32	63	G 1 1/4	110	219	80	183	200	164	G 1/4	50
	80			240	101	205	217	180	G 1/4	
	100			292	127	255	261	226	G 1/4	
40	63	G 1 1/2	120	222	80	188	203	170	G 1/4	55
	80			244	101	209	220	185	G 1/4	
	100			295	127	260	264	230	G 1/4	
	125			324	153	289	287	253	G 1/4	
50	63	G 2	150	249	80	204	230	185	G 1/4	70
	80			270	101	225	246	201	G 1/4	
	100			317	127	272	287	242	G 1/4	
	125			347	153	302	310	265	G 1/4	
65	63	G 2 1/2	185	275	80	218	256	199	G 1/4	85
	80			296	101	239	272	215	G 1/4	
	100			344	127	287	314	257	G 1/4	
	125			374	153	317	337	280	G 1/4	

**2000 threaded port
System On/Off Classic
8801-YA/8803-YA**

Ordering information for valve system On/Off Classic Type 8801-YA/8803-YA

A valve system On/Off Classic Type 8801-YA/8803-YA consists of an angle-seat valve Type 2000 and a valve actuation system control head Type 8691, a pneumatic control unit Type 8690 or an electrical position feedback Type 1062 (see separate datasheets).

For the configuration of further valve systems please use the "Request for quotation" on p. 12 [go to page](#)
You order two components and receive a complete assembled and certified valve.

Ordering the valve system On/Off Classic Type 8801-YA/8803-YA

**Angle-seat valve
Type 2000 threaded port**



Control units



8691
(for actuator
sizes 50-125 mm)



8690
(for actuator
sizes 50-125 mm)



1062

**Angle-seat valve with
desired control unit**

For port connections weld end and clamp, see separate datasheets



**Valve system
On/Off Classic
Type 8801-YA-H
2000 + 8691**



**Valve system
On/Off Classic
Type 8801-YA-K
2000 + 8690**



**Valve system
On/Off Classic
Type 8803-YA
2000 + 1062**

When you click on the orange box "More info." below, you will come to our website for the resp. product where you can download the datasheet.

Control head Type 8691



**More
info.**

The new generation of integrated control heads for combination with actuators from the process valve series Type 20xx/21xx is specially designed for the requirements of hygienic process environments. The intelligent control head, Type 8691, detects the valve position by means of a contact-free analog position sensor circumventing excessive wear of mechanical parts. Single or double-acting actuators are controlled via the integral pilot valve. Communication interfaces AS-Interface and DeviceNet are available as options.

Main customer benefits:

- Automatic setting of the control head at the push of a button
- Even under dirty or dark environments, a clearly visible status display due to powerful LEDs
- Monitoring and diagnosis: Process valve systems with field bus interface used in modern plant processes
- Integrated pilot valve with manual actuation
- Air intake filter enhances the process valve system availability
- Simple and reliable actuator adaptations allowing additional actuators of the process valve series, Type 20xx or actuators from other manufacturers to be used

**Pneumatic control unit
Type 8690**



**More
info.**

The new generation of integrated controllers for combination with actuators from the process valve series Type 20xx/21xx is specially designed for the requirements of hygienic process environments. The pneumatic control unit Type 8690 combines electrical position feedback and pneumatic control for single or double-acting actuators, and is also optionally available as an intrinsically safe model to ATEX.

Main customer benefits:

- Integrated pilot valve with manual actuation
- Air intake filter enhances the process valve system availability
- Simple and reliable actuator adaptations allowing additional actuators of the process valve series, Type 20xx or actuators from other manufacturers to be used

**Electrical Position Feedback
Type 1062**



**More
info.**

Positions are electrically signaled according to switch type:

- open,
- closed or
- open and closed.

LEDs provide optical position indication (except for Namur Ex-version). Mechanical or inductive switches are housed in a compact splash-proof enclosure. The position indicator can be rotated 360° and is easily fitted to the valve. Trip cams do not require adjustment. The unit only needs to be screwed on and connected to be ready for operation.

Dimensions for valve system On/Off Classic Type 8801-YE-H [mm]

Dimensions valve system On/Off Classic Type 8801-YA-H with TopControl Type 8691 [mm]

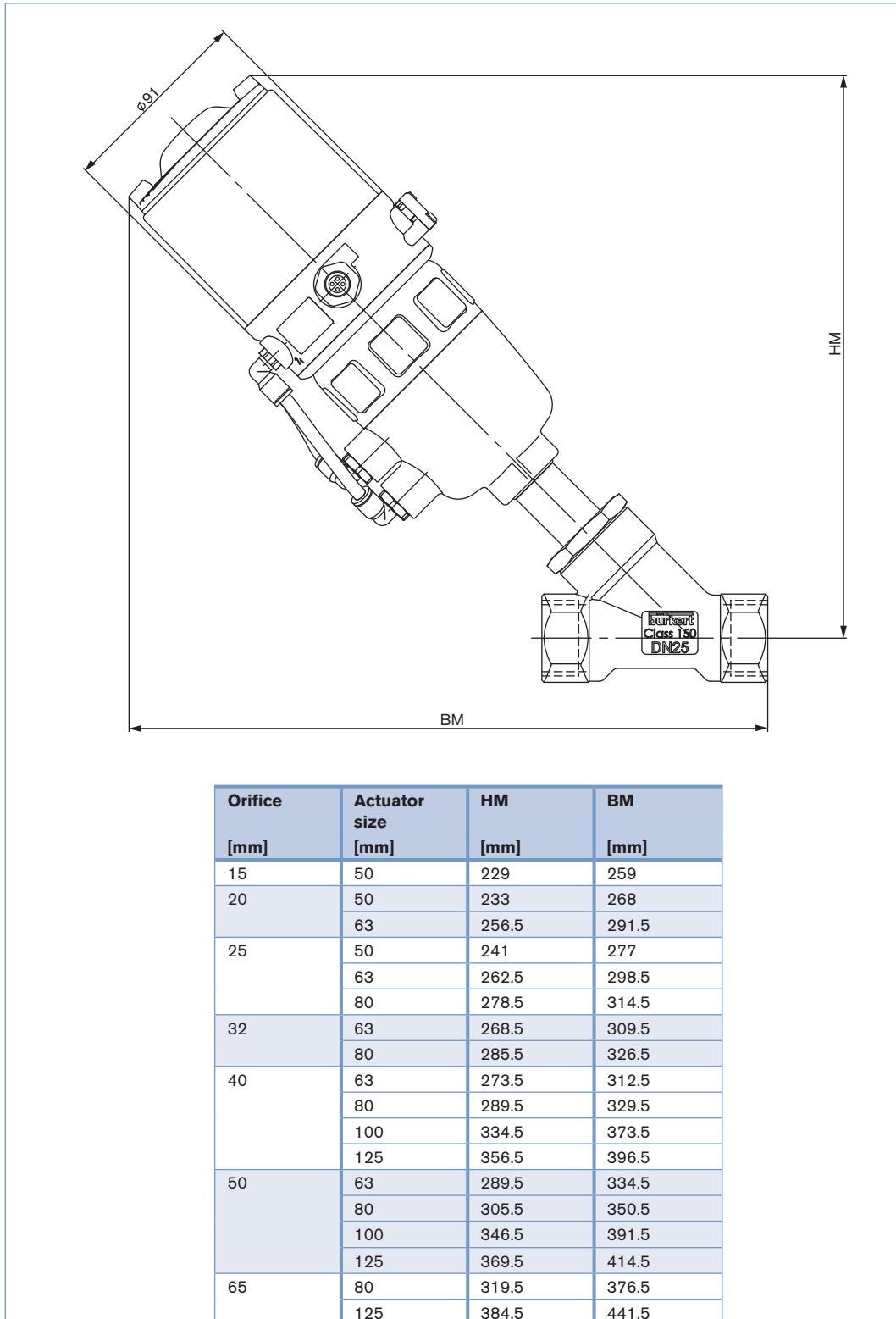

Dimensions for valve system On/Off Classic Type 8801-YE-K [mm]

Dimensions valve system On/Off Classic Type 8801-YA-K with TopControl Type 8690 [mm]

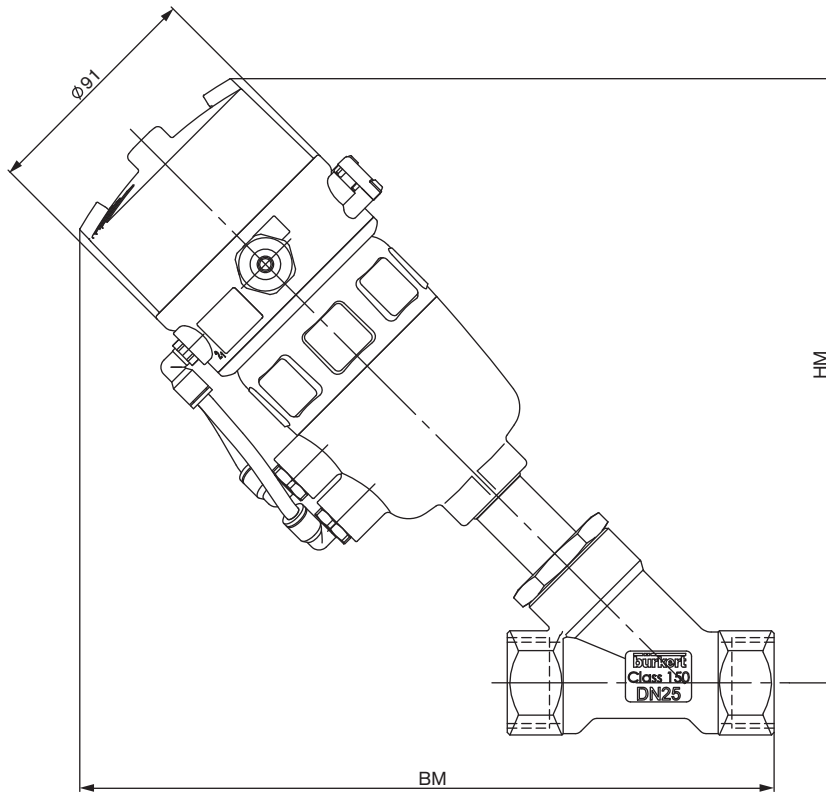

Orifice [mm]	Actuator size [mm]	HM [mm]	BM [mm]
15	50	205	235
20	50	209	244
	63	233	268
25	50	217	253
	63	239	275
	80	254.5	290.5
32	63	245	286
	80	261.5	302.5
40	63	250	289
	80	265.5	305.5
	100	310.5	349.5
	125	332.5	372.5
50	63	266	311
	80	281.5	326.5
	100	322.5	367.5
	125	345.5	390.5
65	80	295.5	352.5
	125	360.5	417.5

Dimensions for valve system On/Off Classic Type 8803-YA [mm]

Dimensions valve system On/Off Classic Type 8803-YA with electrical position feedback Type 1062 [mm]

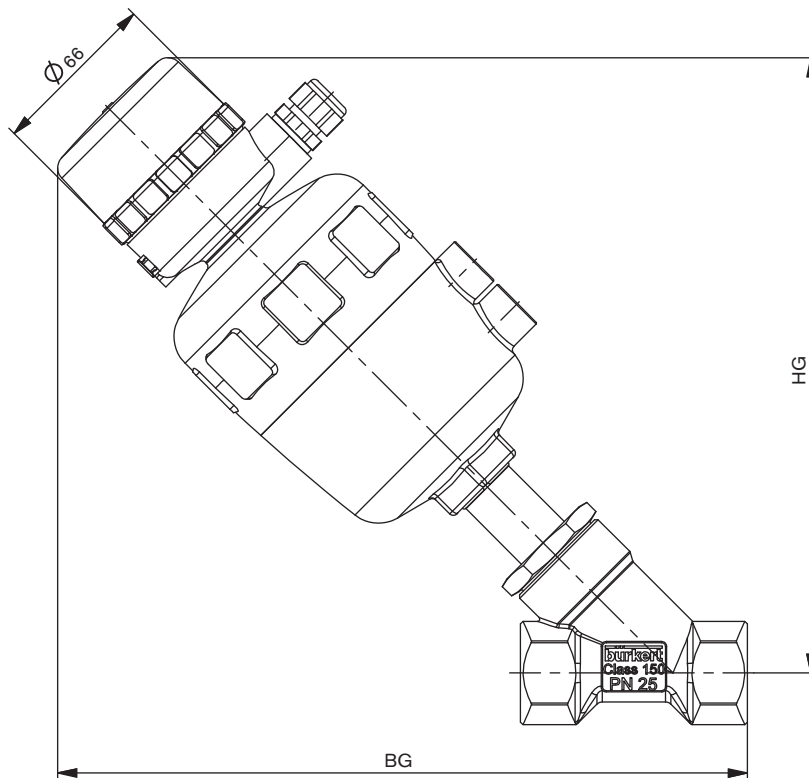

Orifice [mm]	Actuator size \varnothing [mm]	HG [mm]	BG [mm]
15	40	179	203
	50	191	218
20	40	184	210
	50	199	222
	63	221	247
25	50	200	230
	63	222	251
	80	238	267
32	63	238	278
	80	256	301
40	63	241	281
	80	259	295
	100	302	342
	125	323	363
50	63	256	301
	80	271	316
	100	314	359
	125	337	382
65	63	270	327
	80	285	342
	100	329	386
	125	352	409

**2000 threaded port
System On/Off Classic
8801-YA/8803-YA**

bürkert

Note

You can fill out the fields directly in the PDF file before printing out the form.

Valve system On/Off Classic Type 8801-YA/8803-YA – request for quotation

Please fill out and send to your nearest Bürkert facility* with your inquiry or order

Company	Contact person
Customer no.	Department
Address	Tel./Fax
Postcode/town	E-Mail

= mandatory fields to fill out

Quantity

Required delivery date

Operating data

Pipeline	DN	<input type="text"/>	PN	<input type="text"/>
Pipe material	<input type="text"/>			
Process medium	<input type="text"/>			
Type of medium	<input type="checkbox"/> Liquid	<input type="checkbox"/> Steam	<input type="checkbox"/> Gas	
	standard	unit		
Flow rate (Q, Q _N , W) ¹⁾	<input type="text"/>	<input type="text"/>		
Temperature at valve inlet	<input type="text"/>			
Absolute pressure at valve inlet	<input type="text"/>			

¹⁾ standard unit: Liquid Q = m³/h; Steam W = kg/h; Gas Q_N = Nm³/h

Valve features

Actuator material	<input type="checkbox"/> PA	<input type="checkbox"/> PPS			
Body material	<input type="checkbox"/> Stainless steel	<input type="checkbox"/> Gunmetal			
Seat sealing material	<input type="checkbox"/> PTFE	<input type="checkbox"/> NBR	<input type="checkbox"/> Other <input type="text"/>		
Nominal pressure	PN	<input type="text"/>			
Nominal size	DN	<input type="text"/>			
Type of connection	<input type="checkbox"/> Welded	<input type="checkbox"/> Internal thread	<input type="checkbox"/> Clamp		
Standard connection	<input type="checkbox"/> ISO	<input type="checkbox"/> DIN	<input type="checkbox"/> ANSI	<input type="checkbox"/> JIS	<input type="checkbox"/> Other <input type="text"/>
Function	<input type="checkbox"/> NC ²⁾	<input type="checkbox"/> NO ²⁾	<input type="checkbox"/> Double-acting		
Pilot pressure	<input type="text"/>	min.	<input type="text"/>	max.	

²⁾ NC: normally closed by spring action; NO: normally open by spring action

Control unit features

Click on the orange box "More info." below... you will come to our website for the resp. product where you can download the datasheet.

Pneumatic Control Unit	Control Head	Electrical position feedback
<input type="checkbox"/> Type 8691 More info.	<input type="checkbox"/> Type 8690 More info.	<input type="checkbox"/> Type 1062 More info.
Pneumatic function <input type="checkbox"/> Single-acting <input type="checkbox"/> Double-acting Pilot air ports <input type="checkbox"/> Push-in connector external ø 6 mm or 1/4" <input type="checkbox"/> Thread G 1/8" Communication <input type="checkbox"/> ASI <input type="checkbox"/> Multipol M12 <input type="checkbox"/> Flat cable clip, 1 m cable <input type="checkbox"/> DeviceNet Please specify item no. if known: <input type="text"/>	Pneumatic function <input type="checkbox"/> Single-acting <input type="checkbox"/> Double-acting <input type="checkbox"/> Without pilot valve Position feedback <input type="checkbox"/> 1x inductive <input type="checkbox"/> 2x inductive <input type="checkbox"/> 1x inductive (NAMUR) <input type="checkbox"/> 2x inductive (NAMUR) <input type="checkbox"/> 1x mechanical <input type="checkbox"/> 2x mechanical Supply voltage <input type="checkbox"/> 24 V / DC (ATEX Zone 2/22) <input type="checkbox"/> Ex ia IIC T6 (ATEX Zone 1) Pilot air ports <input type="checkbox"/> Push-in connector <input type="checkbox"/> Thread G 1/8" external ø 6 mm or 1/4" Please specify item no. if known: <input type="text"/>	Limit switches <input type="checkbox"/> mechanical <input type="checkbox"/> Voltage 12-48 V <input type="checkbox"/> Voltage 110-250 V <input type="checkbox"/> inductive <input type="checkbox"/> NAMUR EExi Status <input type="checkbox"/> closed <input type="checkbox"/> open <input type="checkbox"/> open/closed Please specify item no. if known: <input type="text"/>

continued on next page →

Valve system On/Off Classic Type 8801-YA/8803-YA – request for quotation, *continued*

Control unit features	
Pilot valve	Stroke limitation
<input type="checkbox"/> Pilot valve	<input type="checkbox"/> Stroke limitation
Power supply <input type="text"/>	<input type="checkbox"/> Min./max. stroke limitation , with visual position indicator
	<input type="checkbox"/> Max. stroke limitation , without visual position indicator
Please specify item no. if known: <input type="text"/>	Please specify item no. if known: <input type="text"/>

Certifications
<input type="checkbox"/> Attestation of compliance with the order EN-ISO 10204 2.1
<input type="checkbox"/> Test report EN-ISO 10204 2.2
<input type="checkbox"/> Certification of Conformity for Raw Material EN-ISO 10204 3.1
<input type="checkbox"/> EN161 (European Gas Device guideline)

Comment / sketch